

Everything you always wanted to
know about flat-fielding but were
afraid to ask*

Richard Crisp

30 January 2012

rdcrisp@earthlink.net

www.narrowbandimaging.com

Outline

- Purpose
- Part 1: Noise
- Part 2: Photon Transfer Analysis: basic concepts (tools we'll use)
- Part 3: Flat Fielding Basic Concepts: what it does, how it works, performance measurement
- Part 4: Field Techniques: taking sky flats, qualifying a master flat prior to deployment

Purpose

- The purpose of this material is to teach
 - What flat fielding does
 - How it works
 - How to quantify results
 - Introduction and use of basic camera analysis tools/techniques
 - How to design an optimized flat fielding protocol for your camera

Goals and Methods

- Our goal is to take optimum flats and know they are optimum
- We want to know how many flat frames to shoot and of what signal level
- The approach we'll follow:
 - Characterize camera to measure full well, camera gain, read noise and Photo-Response-Non-Uniformity (“PRNU”)
 - Use these parameters to select the signal level for the flat frames and number of frames used for the master
- To do this we will start out with a brief overview of noise followed by a brief overview of photon transfer analysis.

Part 1: Noise

- Image noise sources
- Noise Equation
- Graphical Representation

Image Noise Sources

- For an unmodulated image (flat field image), the key noise sources* are
 - Read noise
 - Signal Shot Noise (aka: photon noise, photon shot noise: it will be called Shot Noise or Signal Shot Noise for the remainder of this document)
 - Fixed Pattern Noise
- Depending on signal level any of them can dominate the noise in a single image frame

*neglecting dark signal noise sources which can be managed by cooling

Read Noise

- The read noise is the noise observed in an image when no signal is present
- The noise in a bias frame approximates the read noise
 - zero length exposure
 - no light applied
 - bias frame noise is always greater than read noise due to dark signal accumulation during finite readout time
- Read noise can obliterate faint signals

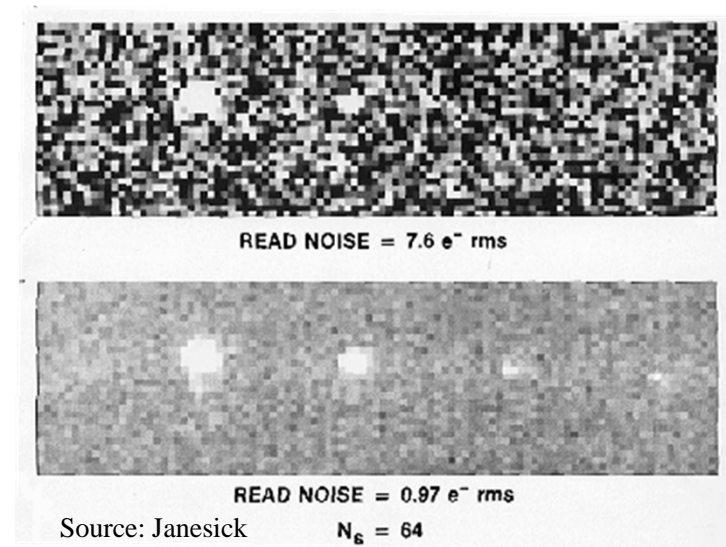

Shot Noise

- The discrete nature of photons results in a variation of the intensity of the incident light as viewed on a photon by photon basis as a function of time
- The variation is the cause of photon shot noise or shot noise as it is also known
- The more intense the image, the greater is the shot noise
- Shot noise is inherent in the image and cannot be avoided and represents the noise floor
- Shot noise in a final image can be eliminated by combining multiple images

IMAGE



PHOTON SHOT NOISE

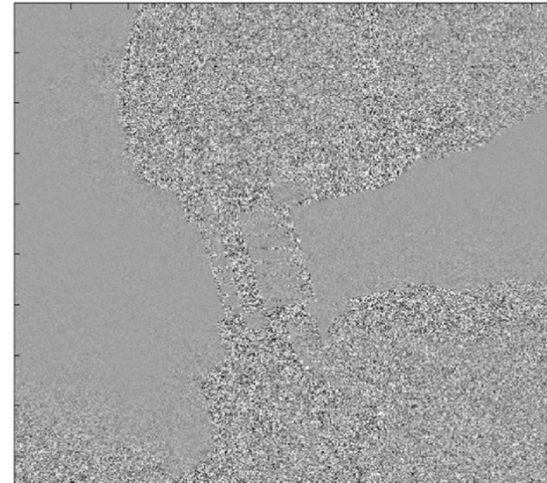

Source: Janesick

Fixed Pattern Noise

- For a flat field exposure, any modulation observed that remains constant from frame to frame is Fixed Pattern Noise (FPN)
- For perfect flat-field illumination of the sensor the FPN observed is caused by variations in the photoresponse of each pixel. This represents the floor of the FPN of the system
- For the camera installed on a practical optical imaging system, variations of light intensity are generally observed
 - Non-uniform light intensity across the frame (ie, “hot centers” or vignetting)
 - Dust motes
 - Filter transmission variations
- These Optical FPN components add to the FPN inherent in the sensor and frequently dominate the overall FPN of the system
- Once FPN dominates the noise of the image, collecting additional signal does not improve the Signal to Noise Ratio (SNR). FPN places an upper limit on the SNR of the system unless removed
- FPN is removed via Flat Fielding (explained later)

Examples of Fixed Pattern Noise

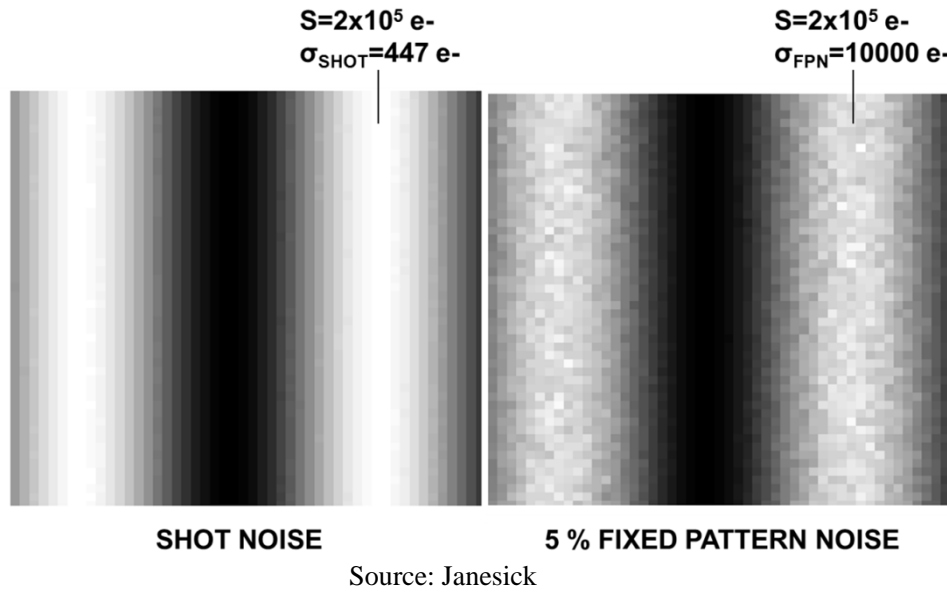

Sensor FPN

Optical FPN

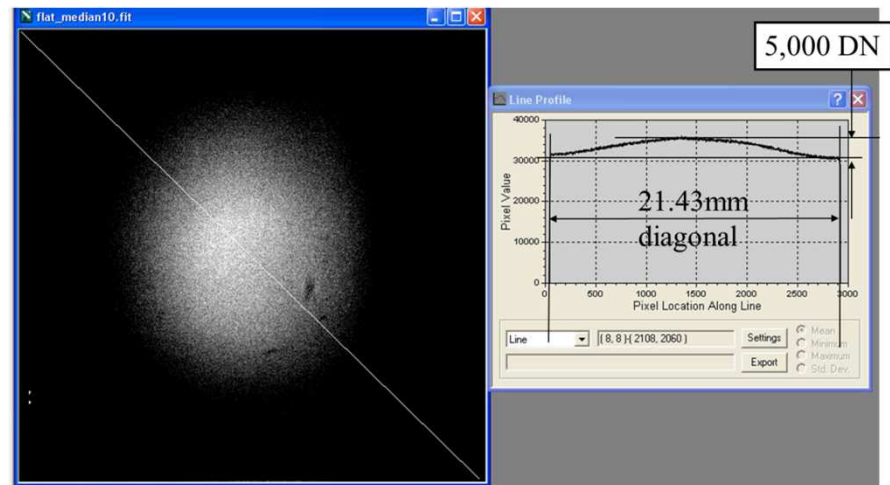

Flat Fielding for FPN Removal

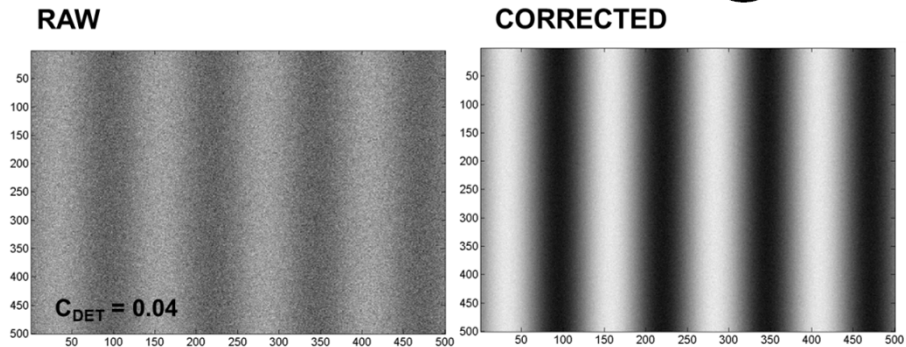

Source: Janesick

Sensor FPN removal

Optical FPN removal

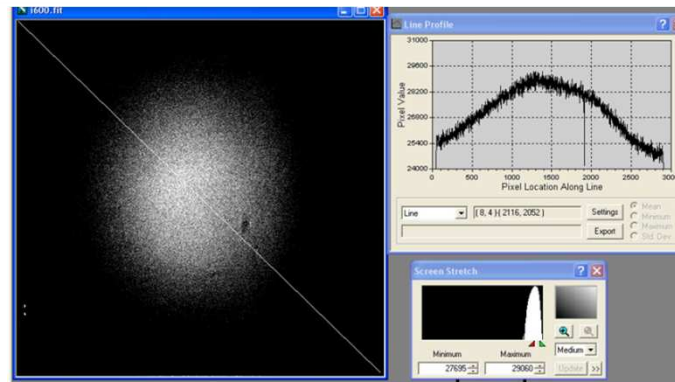

More uniform light distribution than measured lens before Flat field: less noise at outer parts of image post/flat field

Tighter range of data values than measured lens in image DN histogram prior to flat field operation

Very tight range of data values in image DN histogram after flat field operation

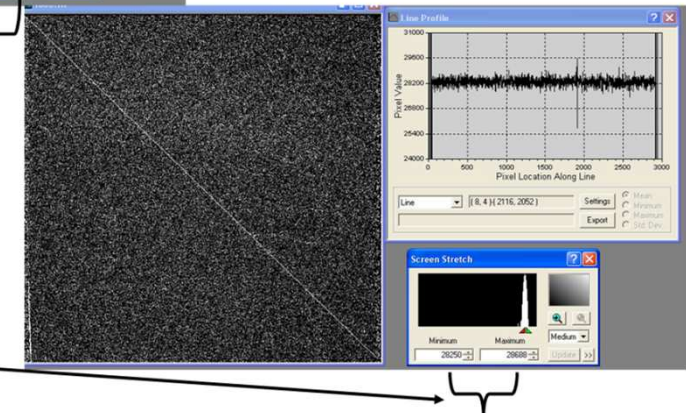

Noise Equation

- To quantitatively analyze noise it must be described mathematically
- When combining the effects of multiple noise sources that are uncorrelated, quadrature summation is used (square root of the sum of the squares of the noise from each separate source)

Noise Equation*

$$Total _ Noise = \sqrt{(read _ noise)^2 + (signal _ shot _ noise)^2 + (fixed _ pattern _ noise)^2}$$

- Assumptions:
 - Flat field target: no modulation
 - Dark signal sources are negligible

Noise Equation Cont'd

$$Total_Noise = \sqrt{read_noise^2 + signal_shot_noise^2 + fixed_pattern_noise^2}$$

recognizing:

$$Signal_Shot_Noise = \sqrt{signal}$$
$$Fixed_pattern_noise = Signal \times PRNU$$

PRNU is Photo-Response-Non-Uniformity
(this will be covered in depth later)

we get:

$$Total_Noise = \sqrt{read_noise^2 + signal + (signal \times PRNU)^2}$$

Graphical Representations

- The noise performance of electronic imaging systems is commonly analyzed using graphical techniques
- Noise is plotted on the Y axis with Signal level plotted on the X axis
- Because the noise and signal may range over several orders of magnitude, it is convenient to use logarithmic axes for the plots to accommodate the large range of data extent

Noise Versus Signal

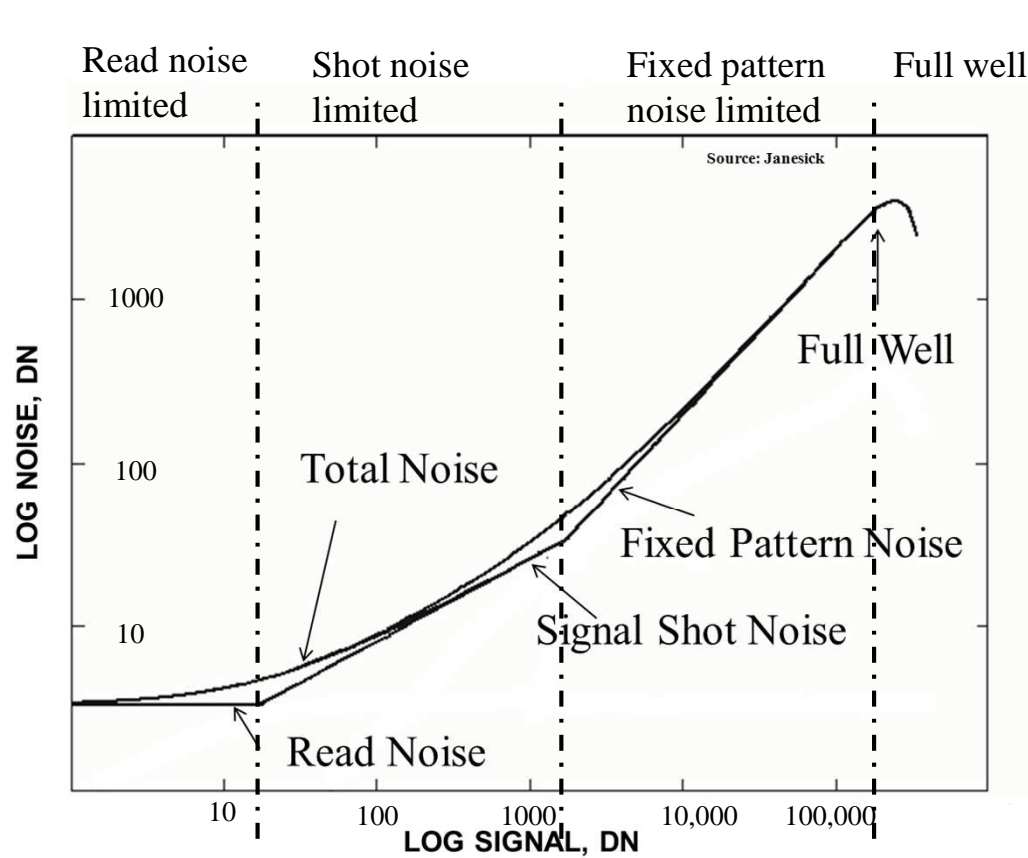

} 4 Regimes of operation

$$Total_Noise = \sqrt{read_noise^2 + signal + (signal \times PRNU)^2}$$

Part 2: Photon Transfer Analysis

Basic Concepts (tools we will use)

- Basic PTC and what we learn from it
- How to make a PTC
- Common PTC errors and how to diagnose and fix them
- Other types of PTCs

Basic PTC and what we learn from it

- A basic Photon Transfer Curve (“PTC”) is a graph of Noise versus Signal measured from a collection of identical pairs of flat-field images of varying signal levels. Typically the noise parameters plotted are Total Noise, Fixed Pattern Noise and Shot Noise
- The signal level of the source images used to make the graph span the range from very low signal level to full well
- Each signal level captured is used as a data point for making the graph
- Once the data is plotted in graphical form we can graphically measure
 - Full well
 - Read Noise
 - Camera Gain (“Kadc”)
 - PRNU
- We can supplement the PTC with dark frame data and learn the DSNU (Dark Signal Non Uniformity: a measure of how noisy the chip is to assist you in establishing a proper operating temperature: ie using an engineering grade sensor without suffering from excessive noise
- We can also make a separate chart to track linearity by plotting Kadc vs Signal using the same dataset

Example PTC

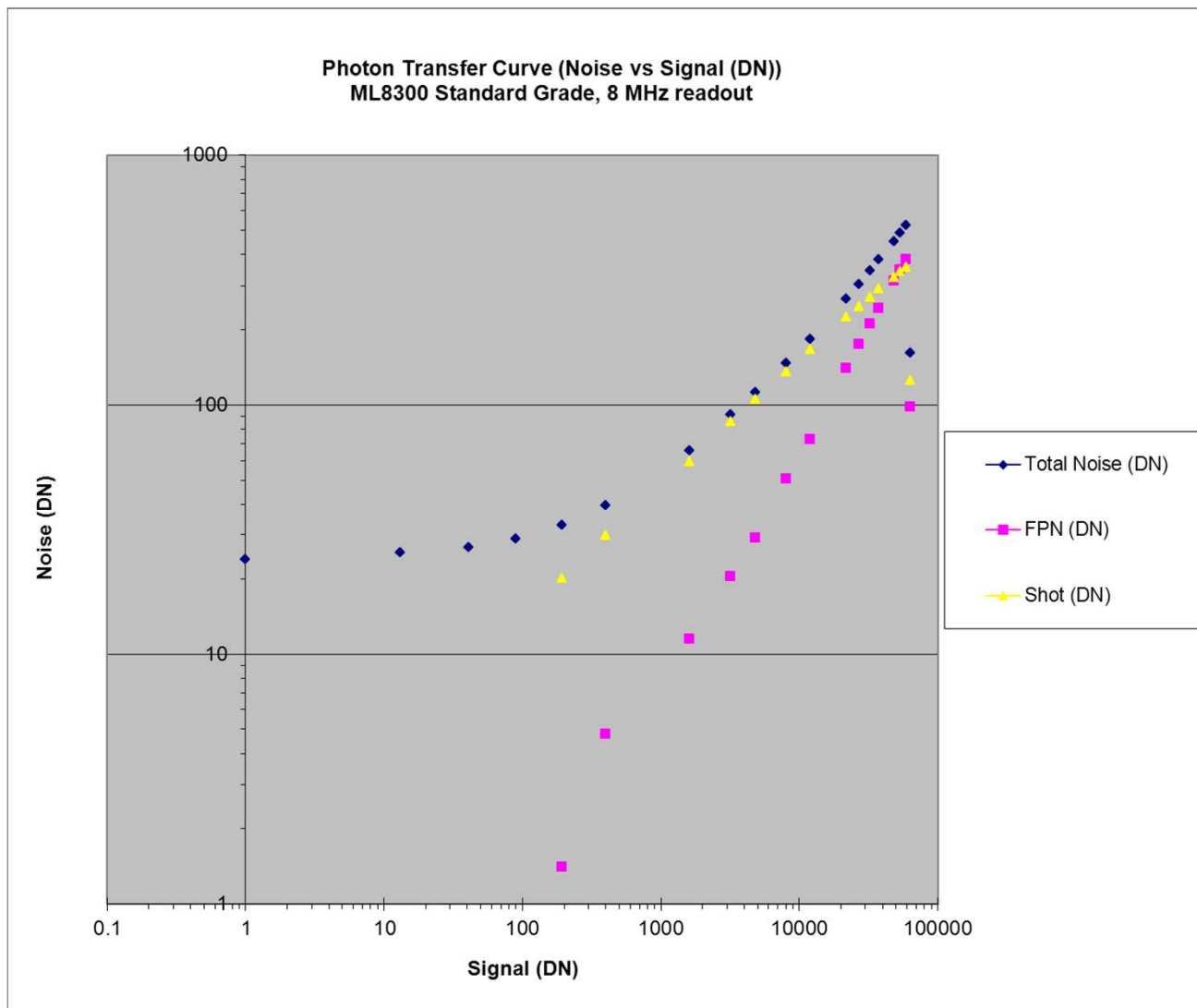

Example PTC: Measuring Gain

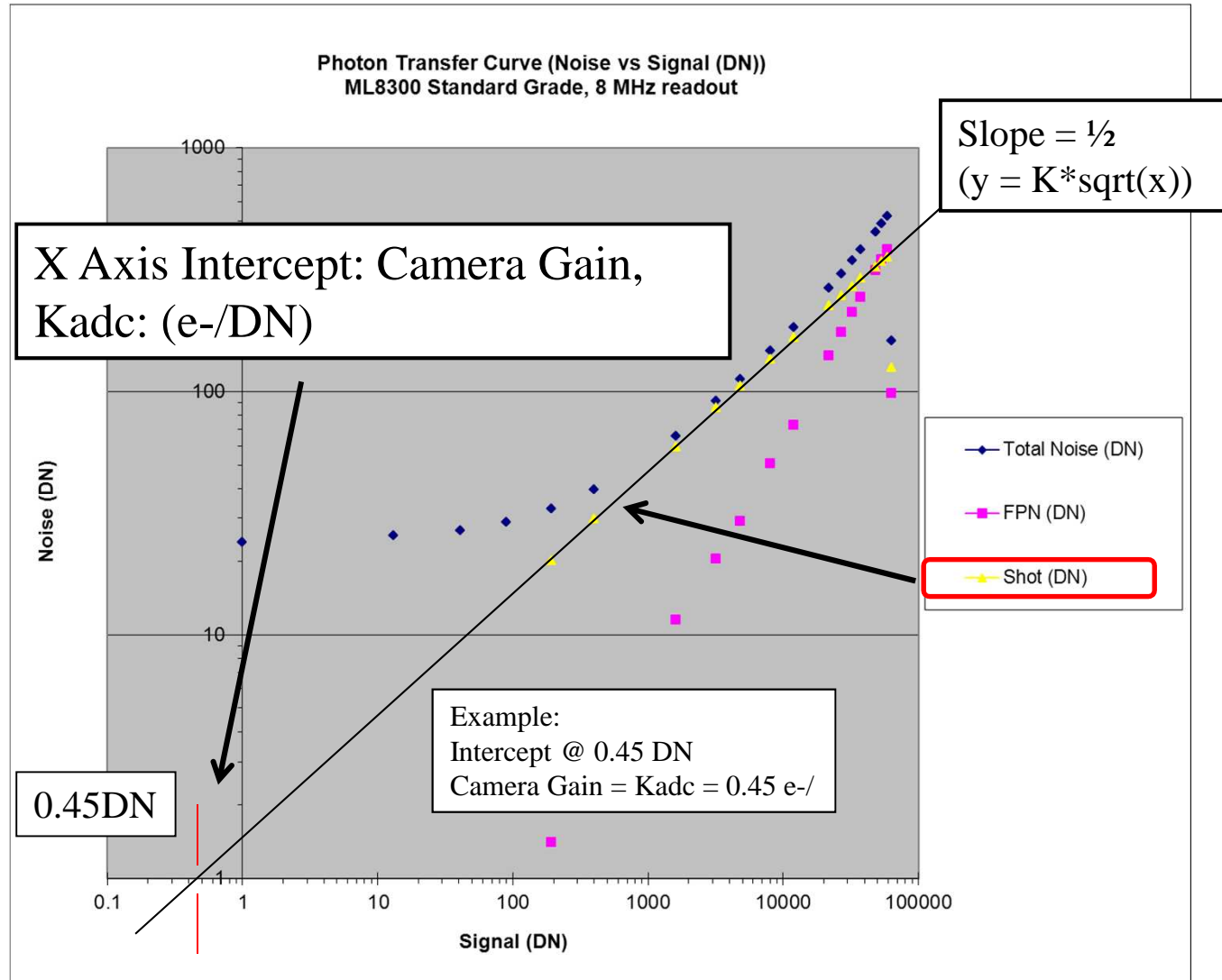

Example PTC: Measuring Read Noise

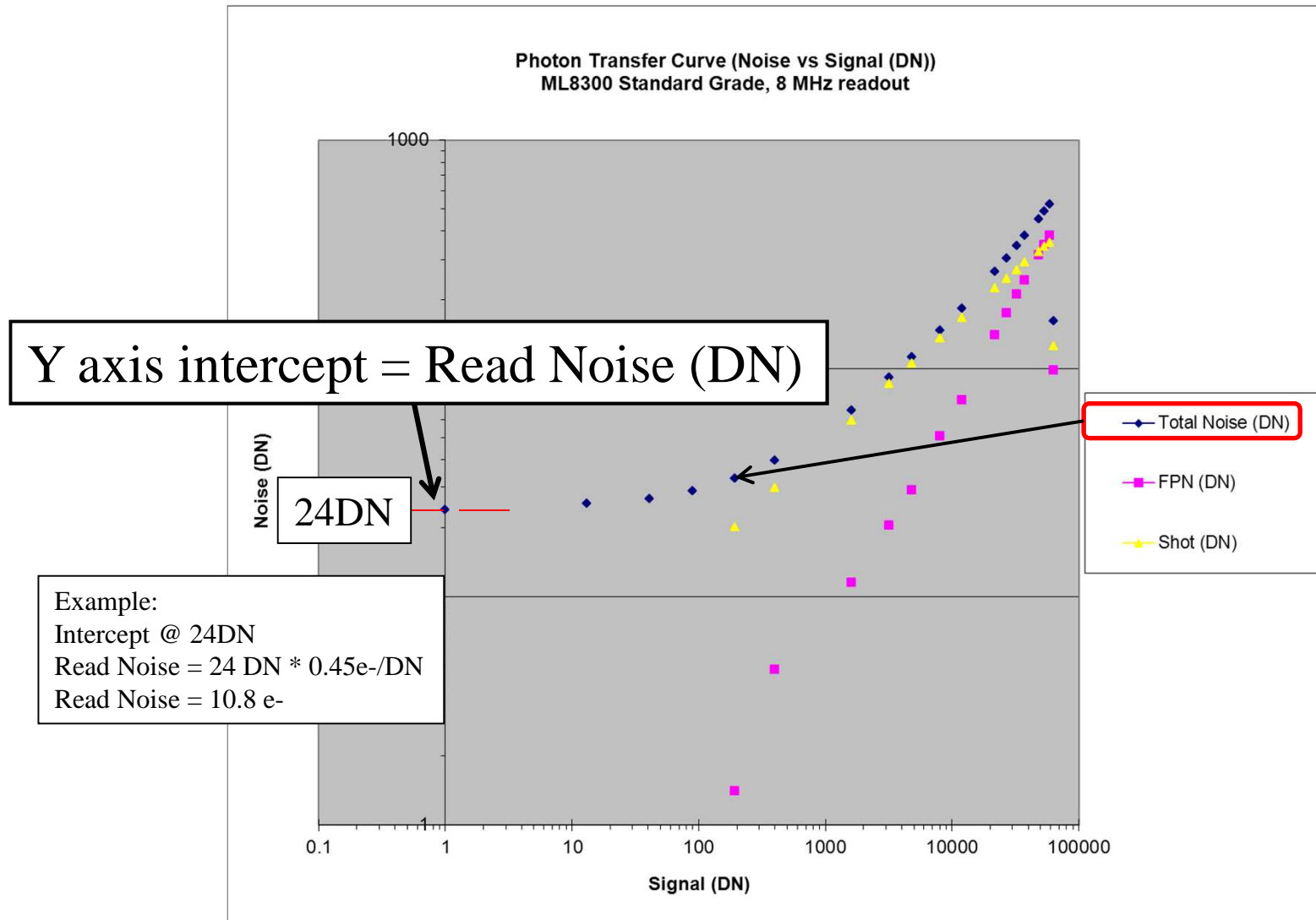

Example PTC: Measuring PRNU

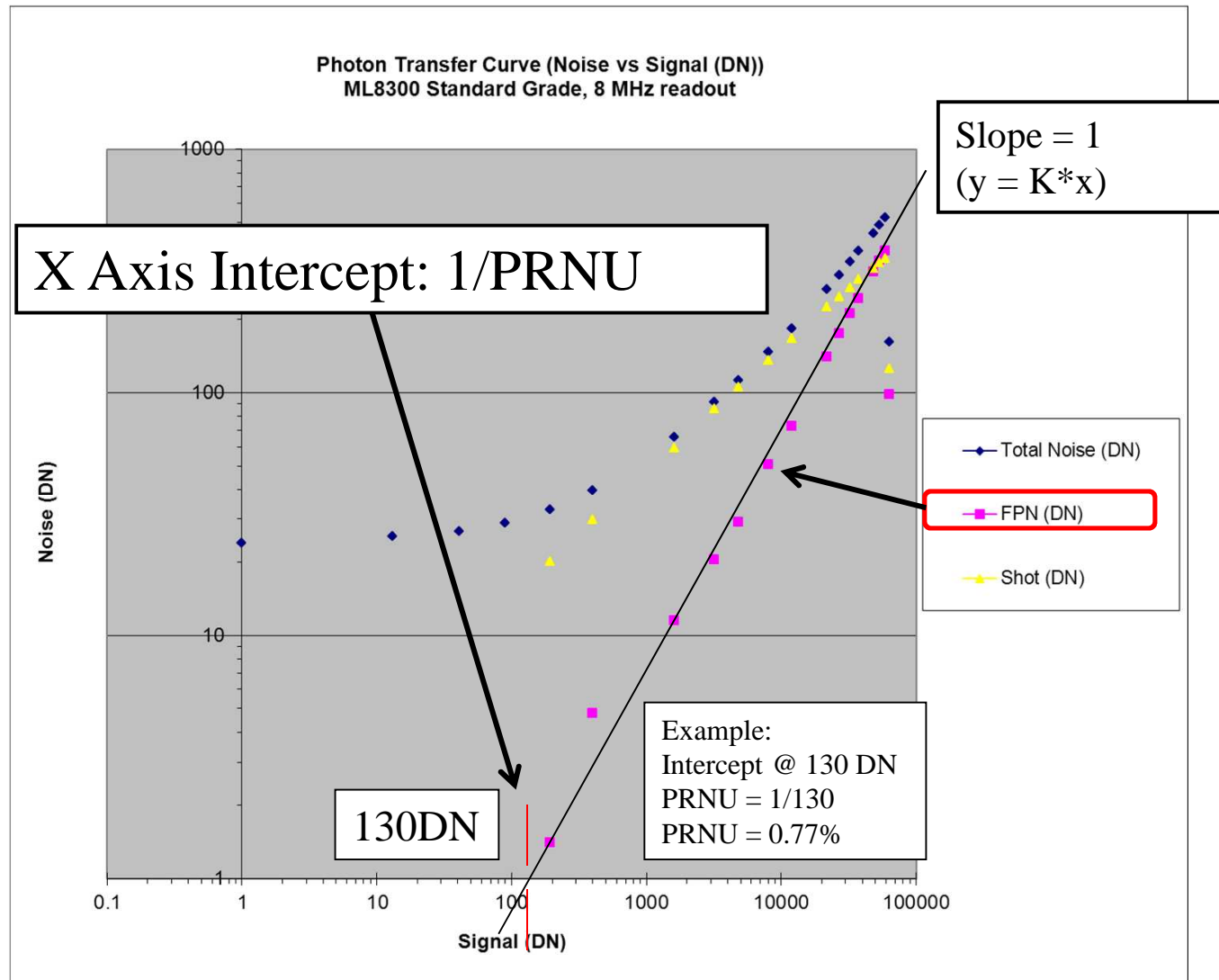

Example PTC: Measuring Full Well

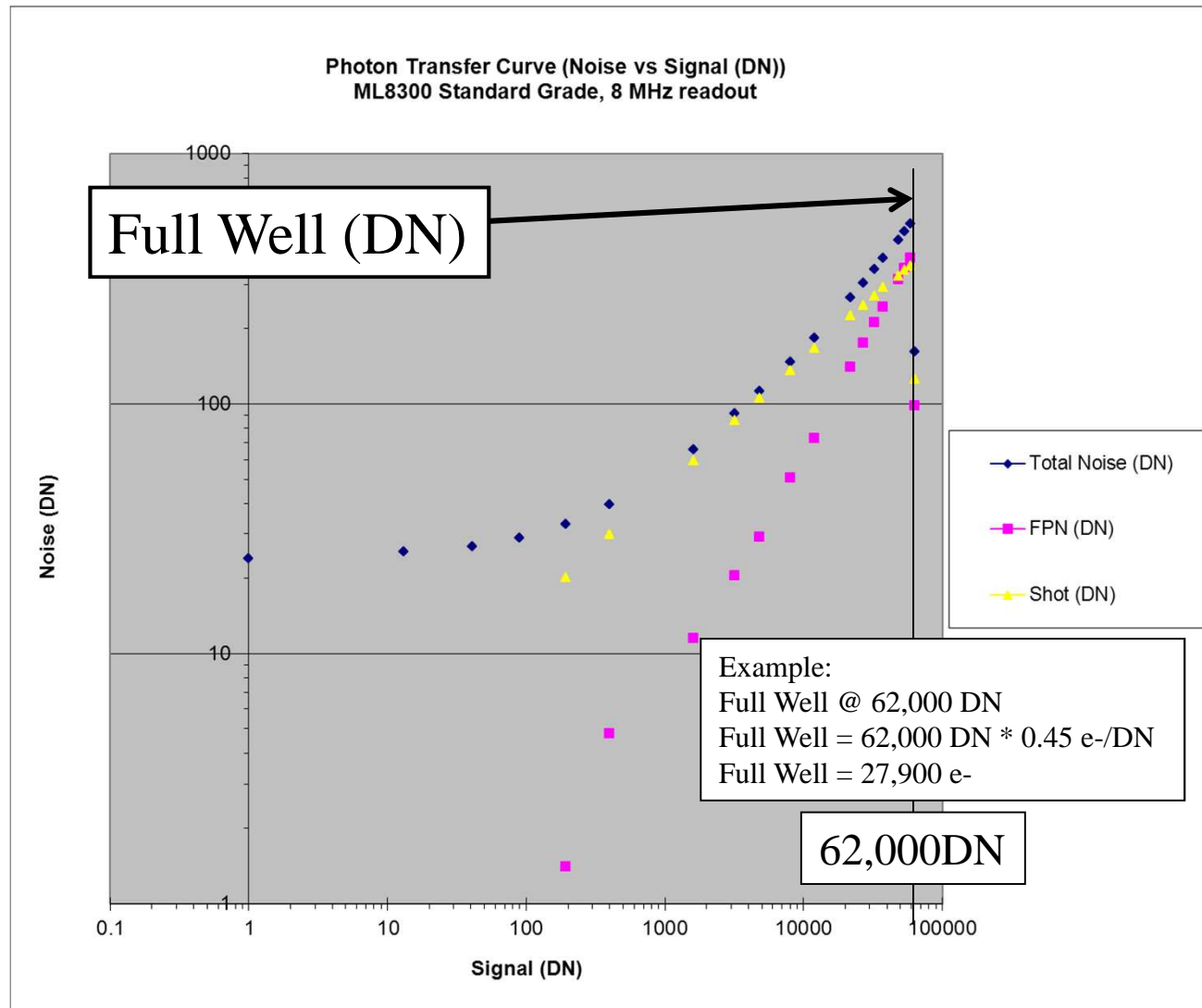

How to make a PTC

- Data Collection:
 - Operate the camera at -25C for the collecting the data below so that dark signal is negligible
 - Collect pairs of identical flat field exposures of varying intensity: ranging from nearly dark to fully saturated. You can do this inside a house with the bare camera looking at a ceiling in a dimly lit room (preferably adjustable light intensity level)
 - Take one bias frame
 - Usually about 16-20 flat pairs is sufficient

Reducing the data

- Using Excel or some other spreadsheet program label several columns for recording data
 - Raw Signal, Offset, Standard Deviation, Delta Standard Deviation, Signal – Offset, Average Signal –Offset, Total Noise, Shot + Read, Read(DN), FPN, Shot, Offset Correction
- Recording measurements from the collected data (this is where it gets tedious)
 - Pick analysis region to use for all data: 100 x 100 yields accuracy of 1% ($\sqrt{\text{\#pixels}}$ = accuracy)
 - Crop the bias frame using the size/location chosen above and measure the average signal level and record that into the OFFSET column in the spreadsheet
 - Crop each image within a flat field pair to the analysis region size/location
 - Using the spreadsheet program record the average value of each cropped frame into the Average Signal column and the standard deviation into the Standard Deviation column (measure this using Maxim DL's "Information" window in "Area" mode)
 - Using Pixel Math in Maxim, subtract one cropped region from the other while adding a fixed value of 5000DN to the minuend (to prevent negative numbers).
 - Record the standard deviation of the difference into the Delta Standard Deviation column in the spreadsheet
 - Repeat for each pair of flats

Filling in the Equations

- The next task is to create equations for the remaining columns
- First fill in the value zero into the Offset Correction column. This value may need to be changed after plotting the data
- Use the following equations for the remaining columns (see the next page)

Equations

- Signal – Offset:
= (signal – offset – offset correction)

signal	offset	std_dev	delta-std	signal-offset	average_signal-offset	total noise shot+rd	read(DN)	FPN	sig_shot	offset_correction
2088	2088	24.147	33.853							0
2087	2087	23.922								0
2097	2088	24.924	35.366							0
2097	2088	24.775								0
2114	2100	25.524	28.174							

Equations

- Average Signal – Offset:

$$= \text{AVG}(\text{signal} - \text{offset} (n), \text{signal} - \text{offset} (n+1))$$



signal	offset	std_dev	delta-std	signal-offset	average_signal-offset	total noise shot+rd	read(DN)	FPN	sig_shot	offset_correction
2088	2088	24.147	33.853							0
2087	2087	23.922								0
2097	2088	24.924	35.366							0
2097	2088	24.775								0
2114	2100	25.521	28.174							0

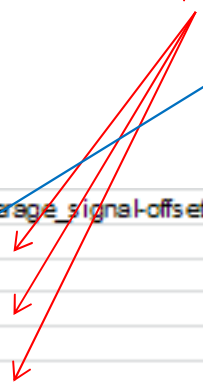
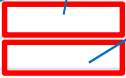

Equations

- Total Noise:

$$= \text{AVG}(\text{std_dev}(n), \text{std_dev}(n+1))$$

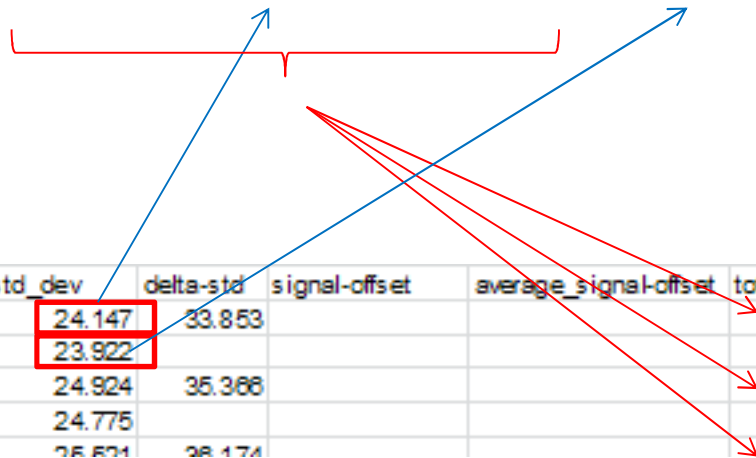

signal	offset	std_dev	delta-std	signal-offset	average_signal-offset	total noise shot+rd	read(DN)	FPN	sig_shot	offset_correction
2088	2088	24.147	33.853							0
2087	2087	23.922								0
2097	2088	24.924	35.366							0
2097	2088	24.775								0
2111	2100	25.521	28.174							0

Equations

- Shot + Rd:
= $\text{delta-std} / \text{sqrt}(2)$

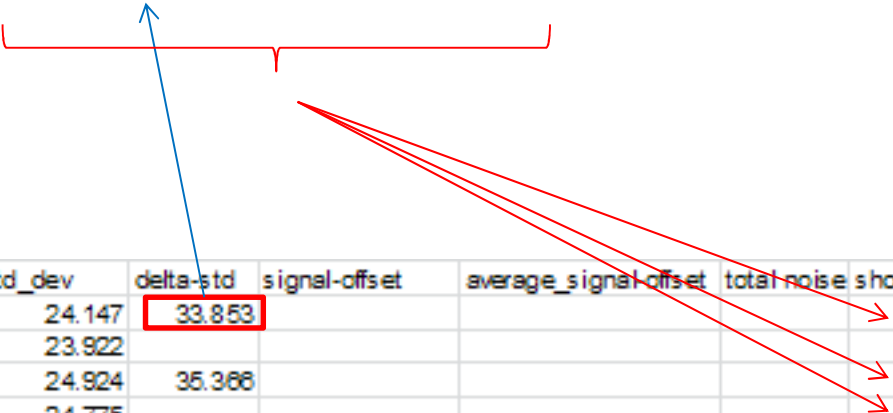

signal	offset	std_dev	delta_std	signal_offset	average_signal_offset	total noise shot+rd	read(DN)	FPN	sig_shot	offset_correction
2088	2088	24.147	33.853							0
2087	2087	23.922								0
2097	2088	24.924	35.366							0
2097	2088	24.775								0
2111	2100	25.521	28.174							0

Equations

- read:

Write in the standard deviation of the cropped bias frame

signal	offset	std_dev	delta-std	signal-offset	average_signal-offset	total noise shot+ro	read(DN)	FPN	sig_shot	offset_correction
2088	2088	24.147	33.853							0
2087	2087	23.922								0
2097	2088	24.924	35.366							0
2097	2088	24.775								0
2111	2100	25.521	28.174							0

= Read (n-1) value
(recursive from previous row)

The value of the read noise will likely be adjusted later to correct a common PTC error

Equations

- Sig Shot:

$$= \text{SQRT}(\text{Shot} + \text{Read}^2 - \text{Read}^2)$$

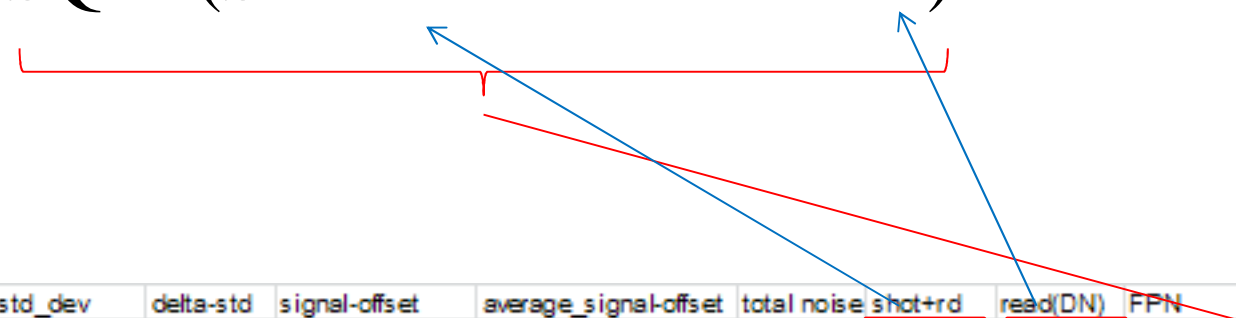

signal	offset	std_dev	delta-std	signal-offset	average_signal-offset	total noise shot+rd	read(DN)	FPN	sig_shot	offset_correction
2088	2088	24.147	33.853							0
2087	2087	23.922								0
2097	2088	24.924	35.366							0
2097	2088	24.775								0
2111	2100	25.521	28.174							

Result

signal	offset	std_dev	delta-std	signal-offset	average_signal-offset	total noise	shot+rd	read(DN)	FPN	sig_shot	offset_correction
2292	2088	32.776	46.31	194	194	32.7765	32.74612	25.8	1.410993	20.16601	10
2292	2088	32.777		194							10
2496	2088	39.729	55.851	398	397.5	39.781	39.49262	25.8	4.781303	29.90029	10
2495	2088	39.833		397							10
3703	2088	65.913	91.78	1605	1605	65.9065	64.89826	25.8	11.48401	59.54951	10
3703	2088	65.9		1605							10

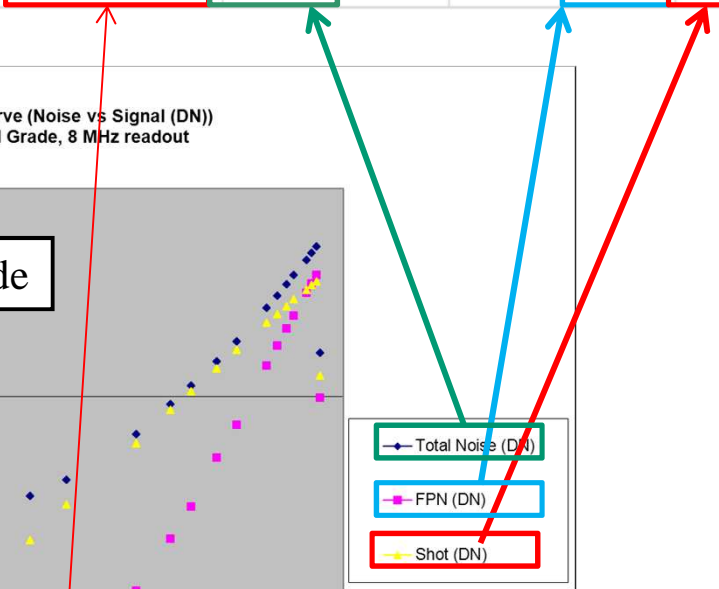
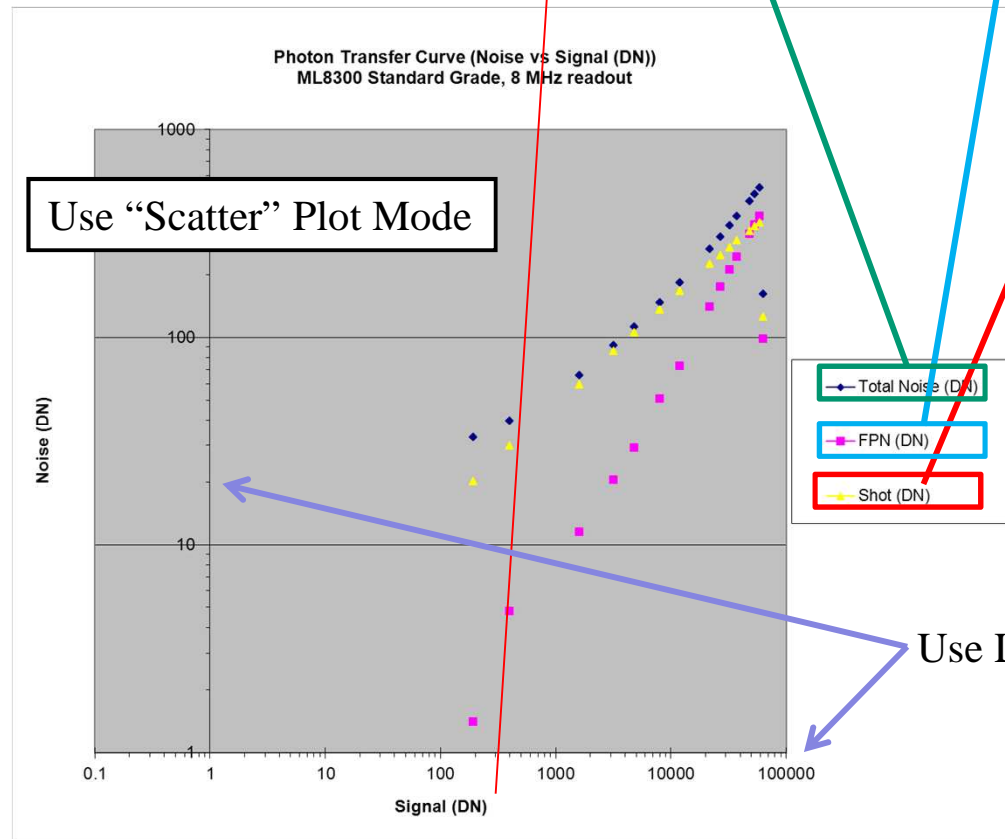

Practical matters: measuring the image data

- After cropping the pair of identical flat field exposures, the average and standard deviation are recorded. Then a fixed offset (recommend 5000DN) is added to the minuend and then one is subtracted from another. The standard deviation of the result is recorded

Practical matters: measuring the image data

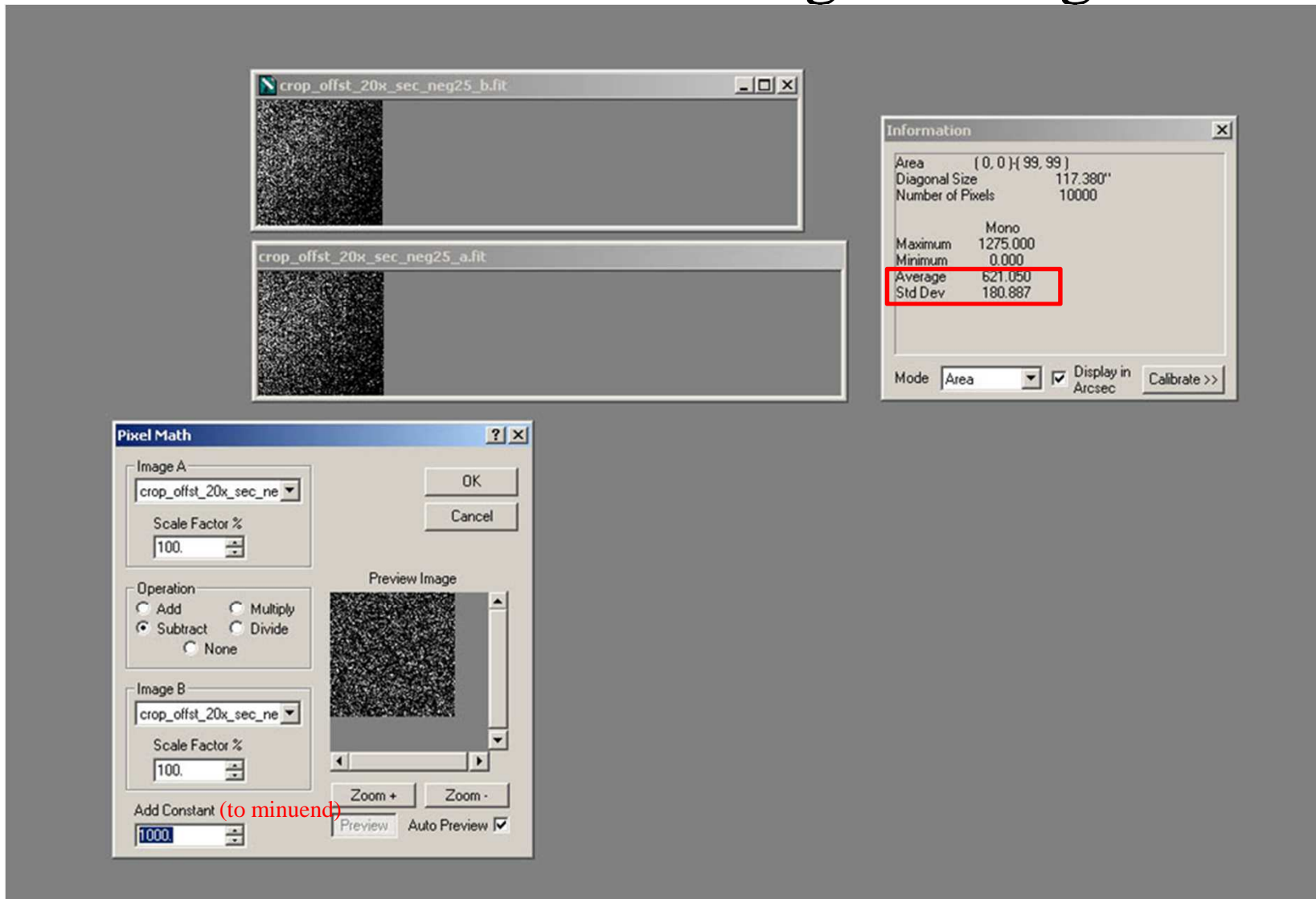

Adding Dark Signal to the PTC

- You can add data taken from dark frames to the same PTC and learn the value of the Dark Signal Non Uniformity (“DSNU”). That is usually called a Dark Transfer Curve (“DTC”)
- Additionally you will pick up lower values for the shot noise curves. The dark signal portion should simply extend the portion derived using flat fields
- From a spreadsheet perspective: simply copy the one you built and place below: then enter data from your dark frames to replace the light-on data. The pairs of identical darks are cropped using the same selection box as for the light-on data
- It is important to take the dark data at elevated temperature:
 - Dark signal accumulates faster
 - The DSNU is measured by the manufacturer at elevated temperatures
 - DSNU tends to increase as temperature is reduced: the low end of the histogram dark current histogram is truncated by thermally generated charge as the temperature is increased. That reduces the variability of the data hence the value of the DSNU.
- Whatever temperature picked, it needs to remain constant so it should be colder than room temperature so that the cooler can maintain a constant temperature

Dark Spikes vs Temperature

Reduced temperature: less thermal current, more variance of dark spikes: increases DSNU

Source: Janesick

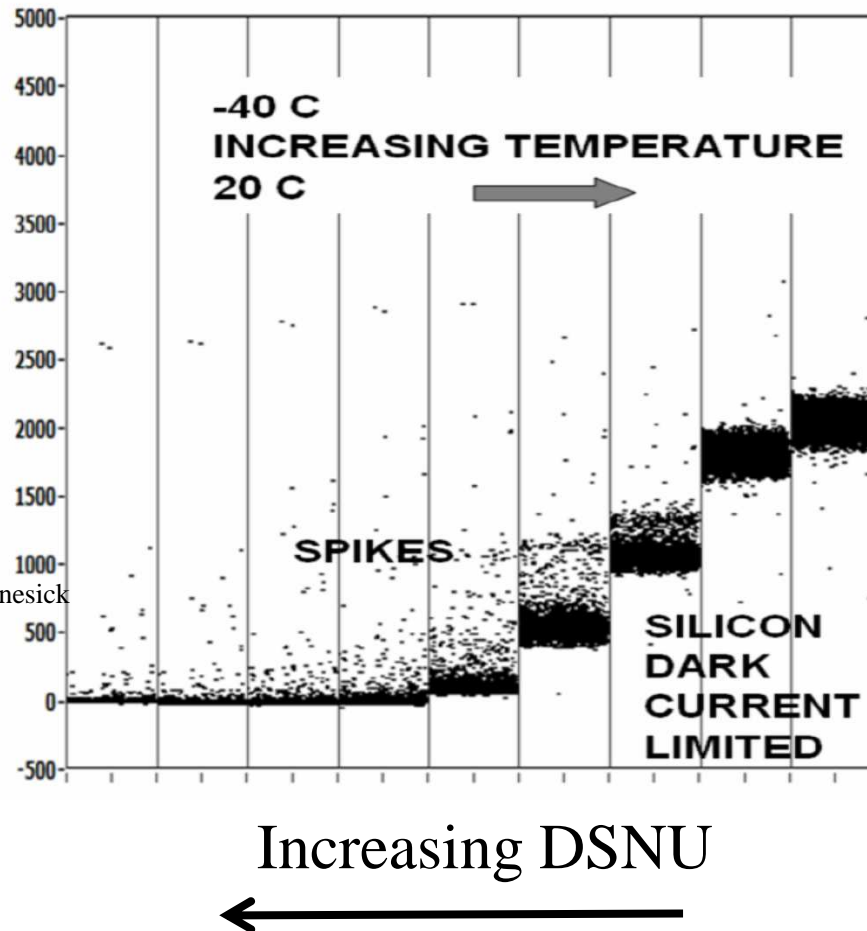

Dark Current Limited: Reduces DSNU

Kodak (now Truesense Imaging) specifies the DSNU at room temperature (25C)

DTC/PTC

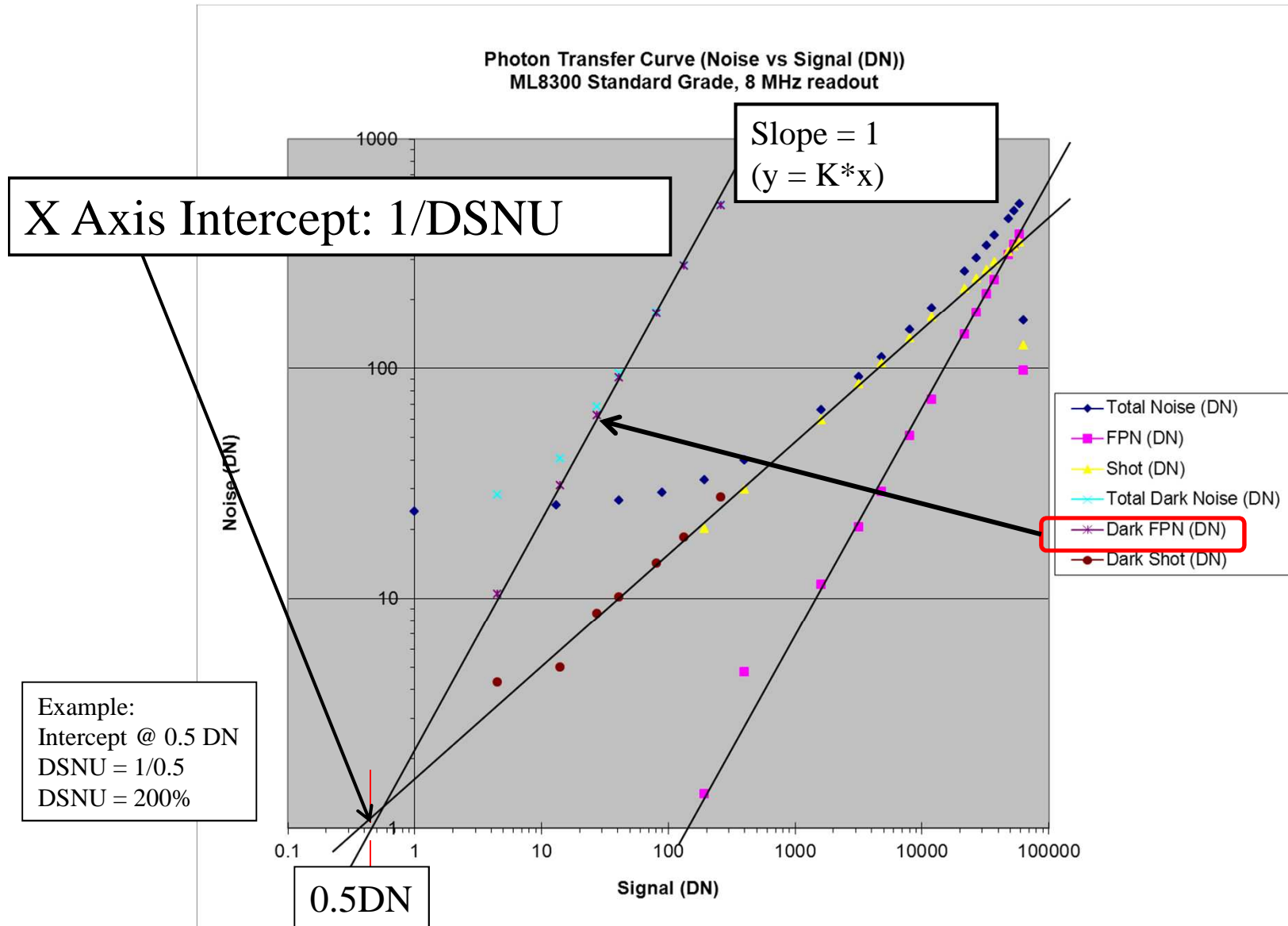

Common PTC Errors

- Common errors for the PTCs are using the wrong value for the read noise and for the offset
- The offset cannot be directly measured, the bias value is close but includes a bit of dark signal and may have other error sources.
- For the read noise a good initial value is the standard deviation of the bias frame. Or you can look at where the total noise crosses the Y axis and use that value.
- The symptoms of error are easy to spot:
 - when the Shot noise and FPN curves doesn't show a straight line to the X axis intercept, that usually means the offset and or read noise is off
- Using the Offset Correction column, the offset can be adjusted to straighten out the FPN curve.
- Then the Read Noise value can be adjusted to better straighten out the shot noise curve. It is common to iterate back and forth a bit.
 - The read noise can be very accurately measured: to 3 significant digits if desired
- For the low-valued flat field pairs, it is helpful to take a bit more exposure pairs because one unfortunately placed noise hit can foul up the low valued data making the offset and read noise adjustments difficult to judge (you may see wild data or negative numbers under a square root)
 - You will possibly have to toss some "flyer" data points as a result.
- It is beneficial to take linearly spaced flats for the low valued ones such as 1, 1.1, 1.2, 1.3, 1.4 etc to not lose data coverage if a few of the pairs are ruined by anomalous pixel events

PTC OFFSET ERROR

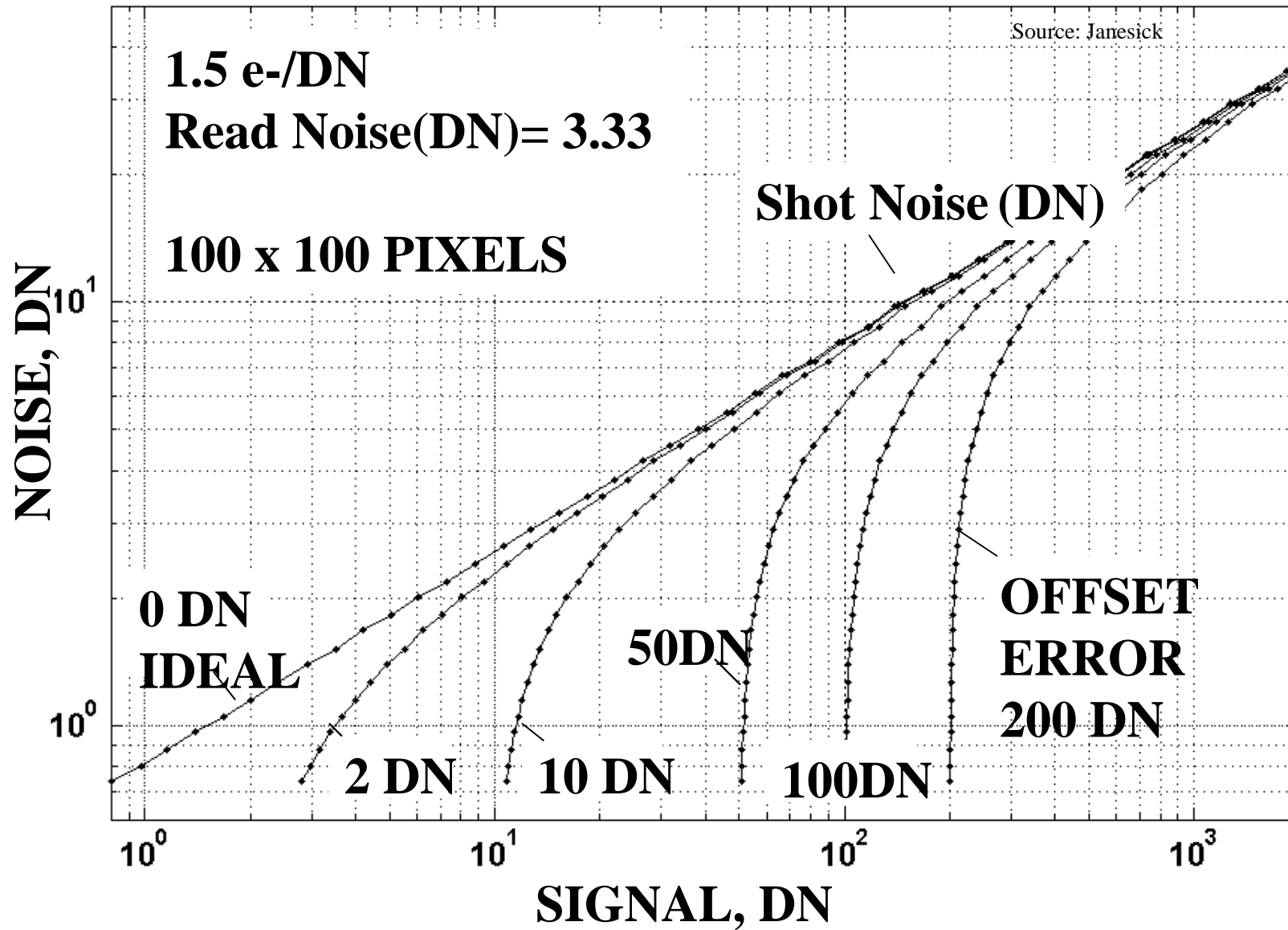

PTC READ NOISE ERROR

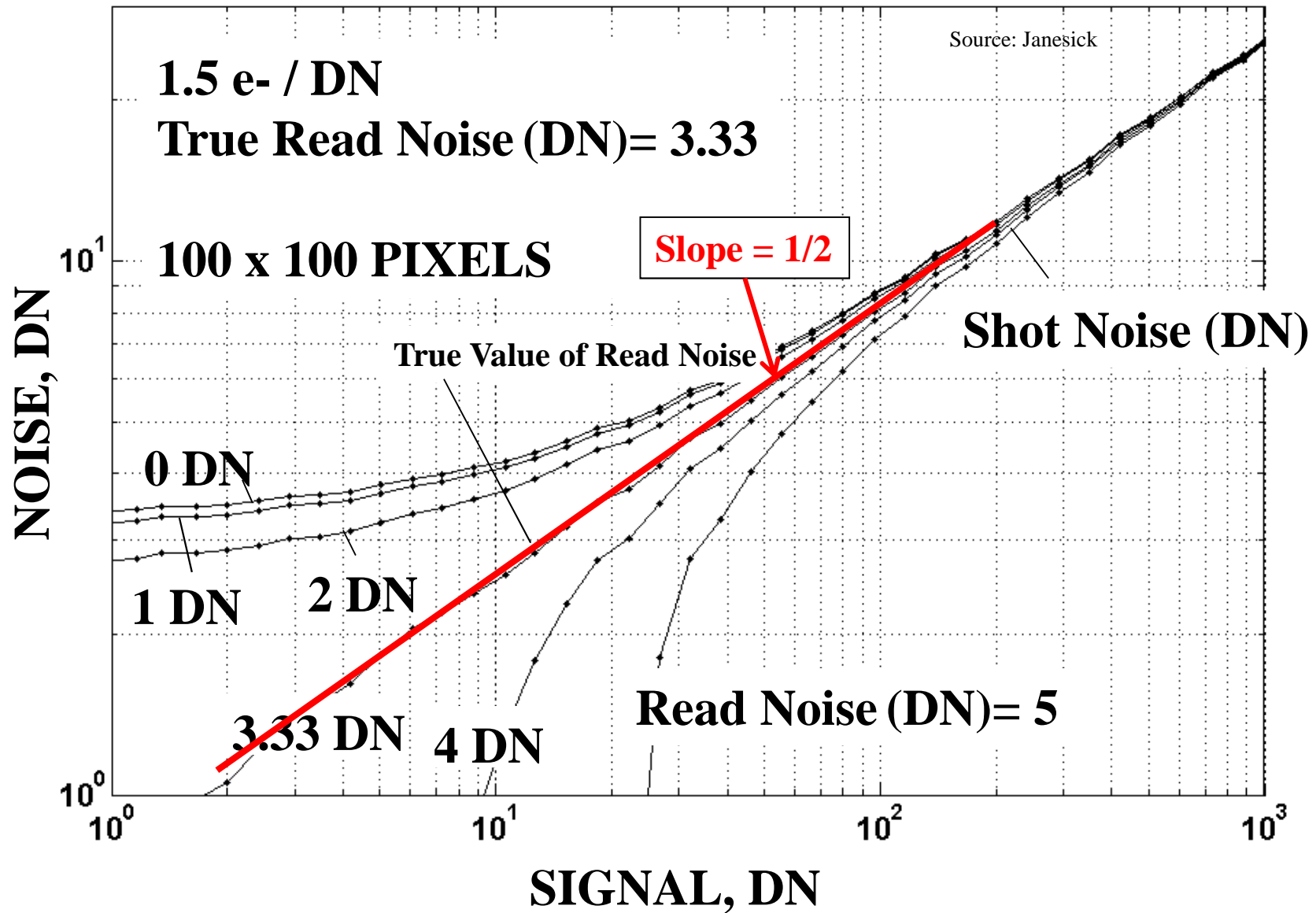

PTC Offset Error

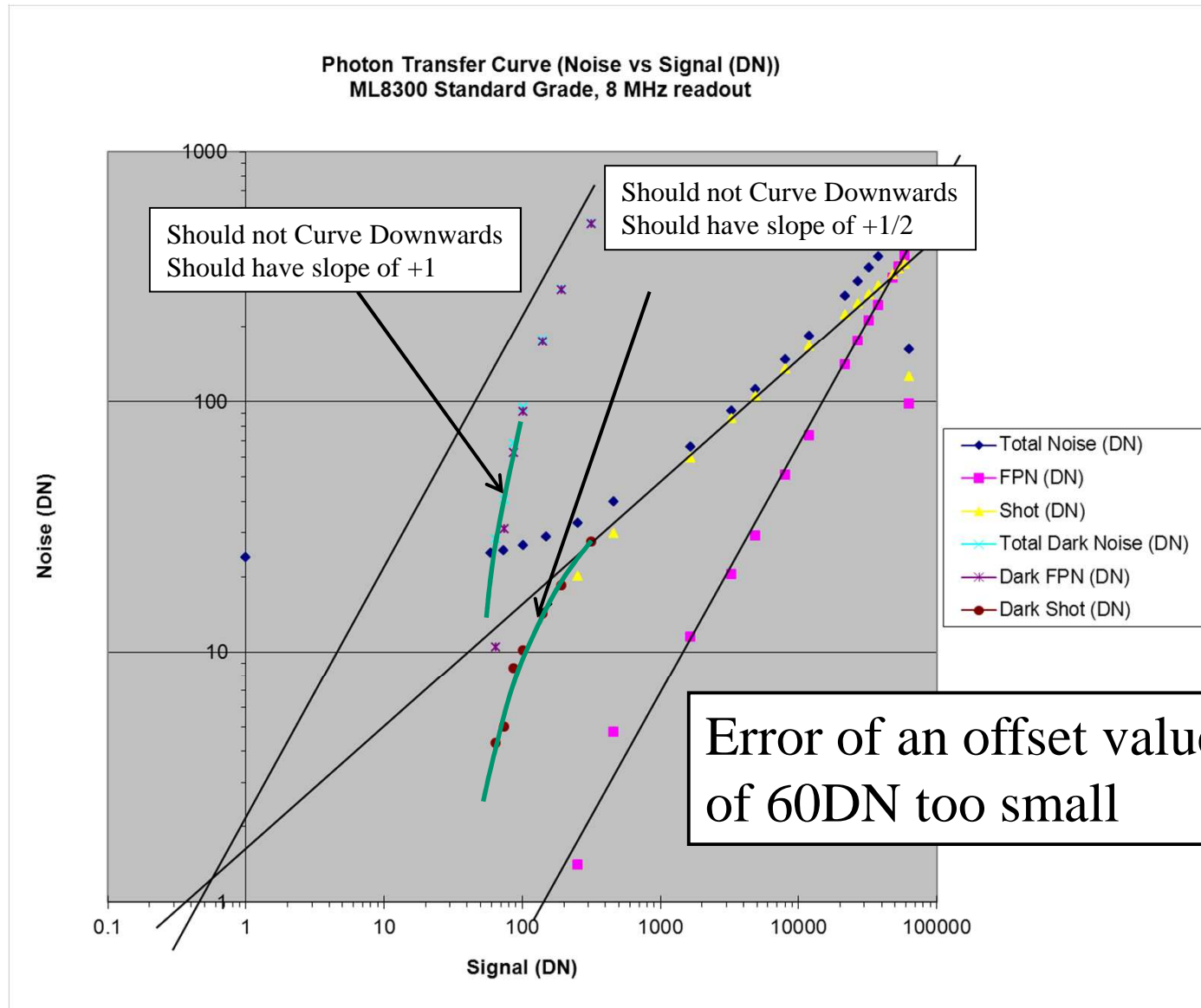

PTC Read Noise Error

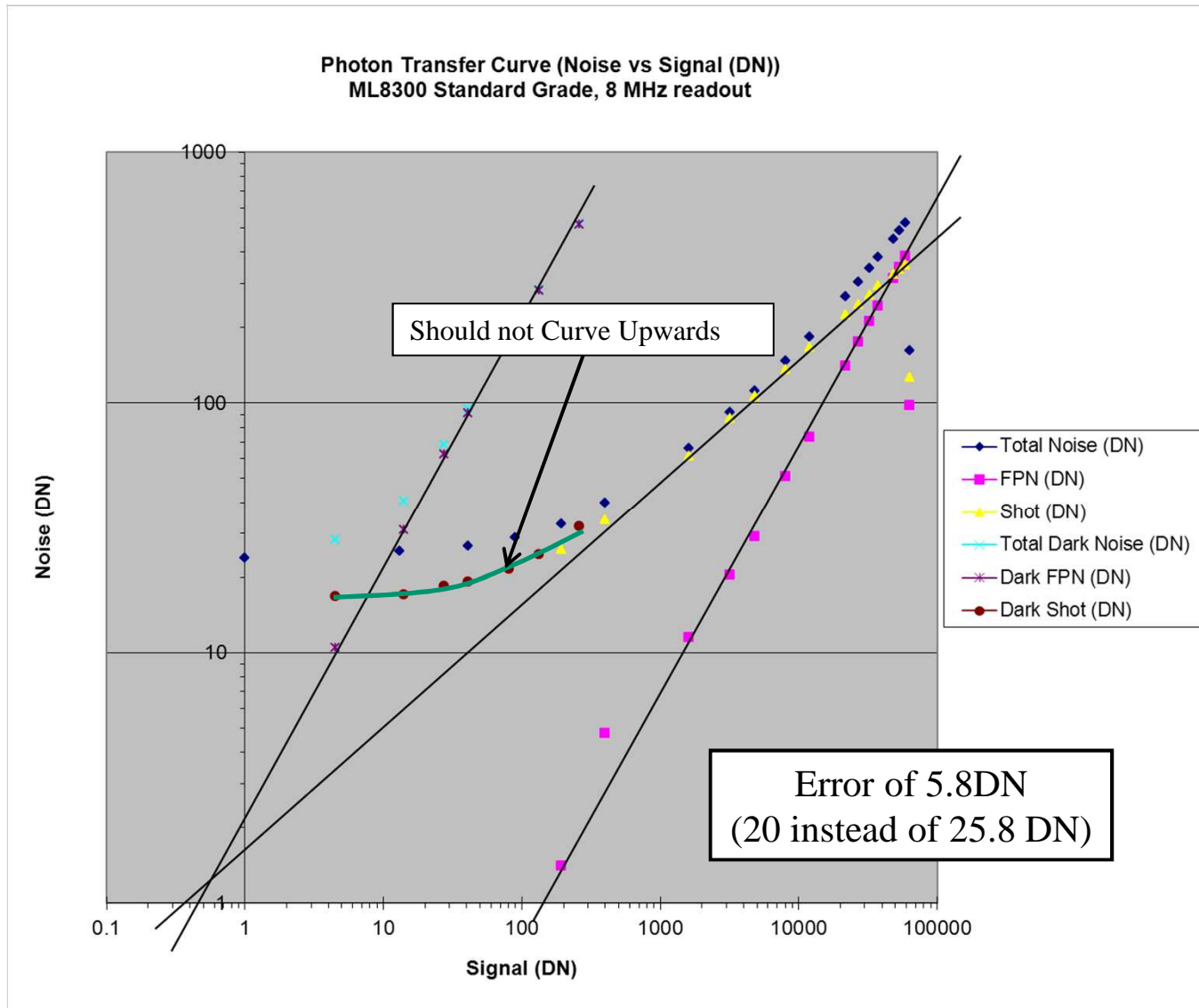

Correct Values of Offset, Read Noise

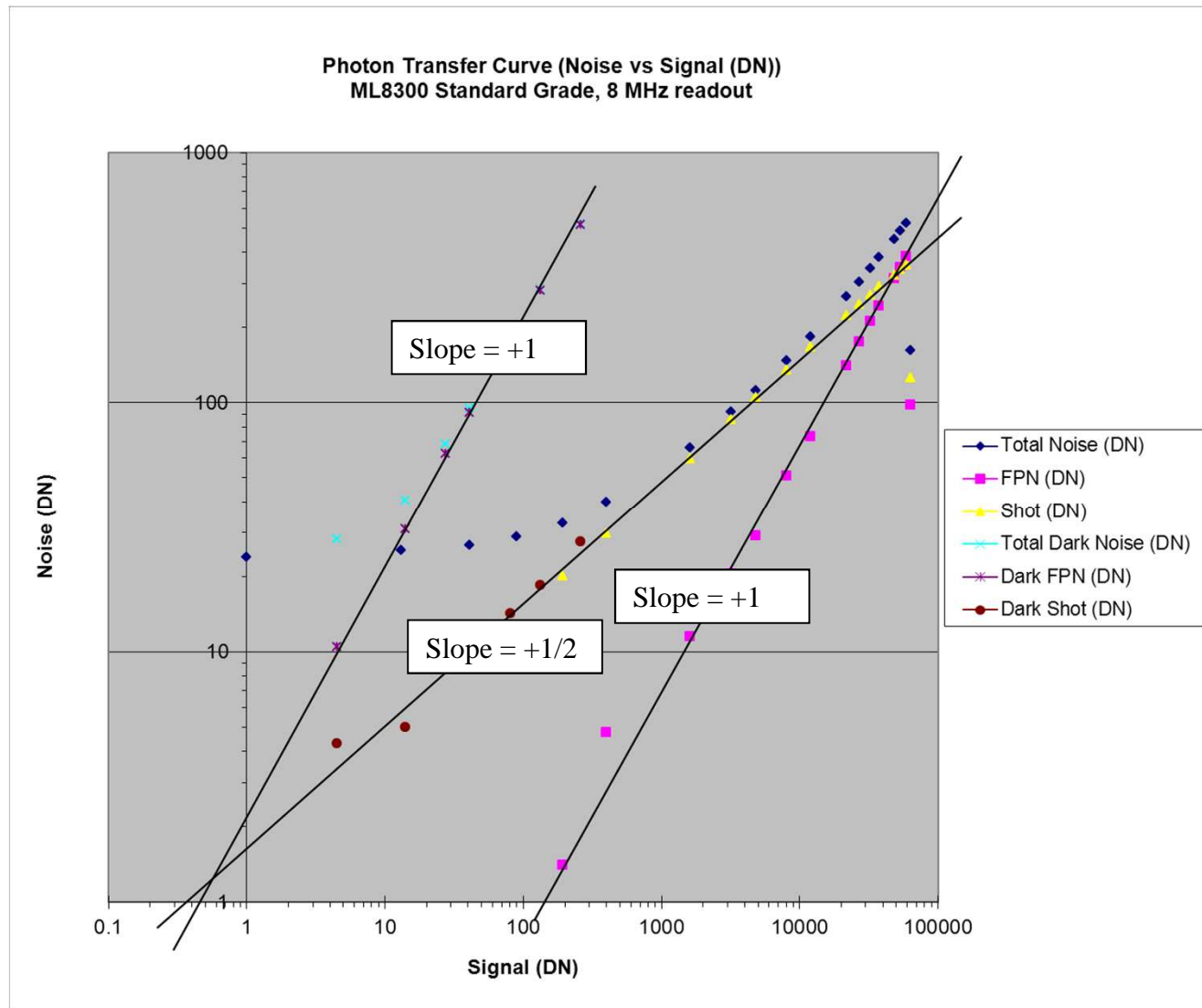

Adding in Linearity

- Kadc can be calculated point by point by the following relation

$$Kadc = \text{signal} / \text{signal_shot}^2$$

- Kadc is very sensitive to offset and read noise errors

Linearity Plot (correct offset, read noise)

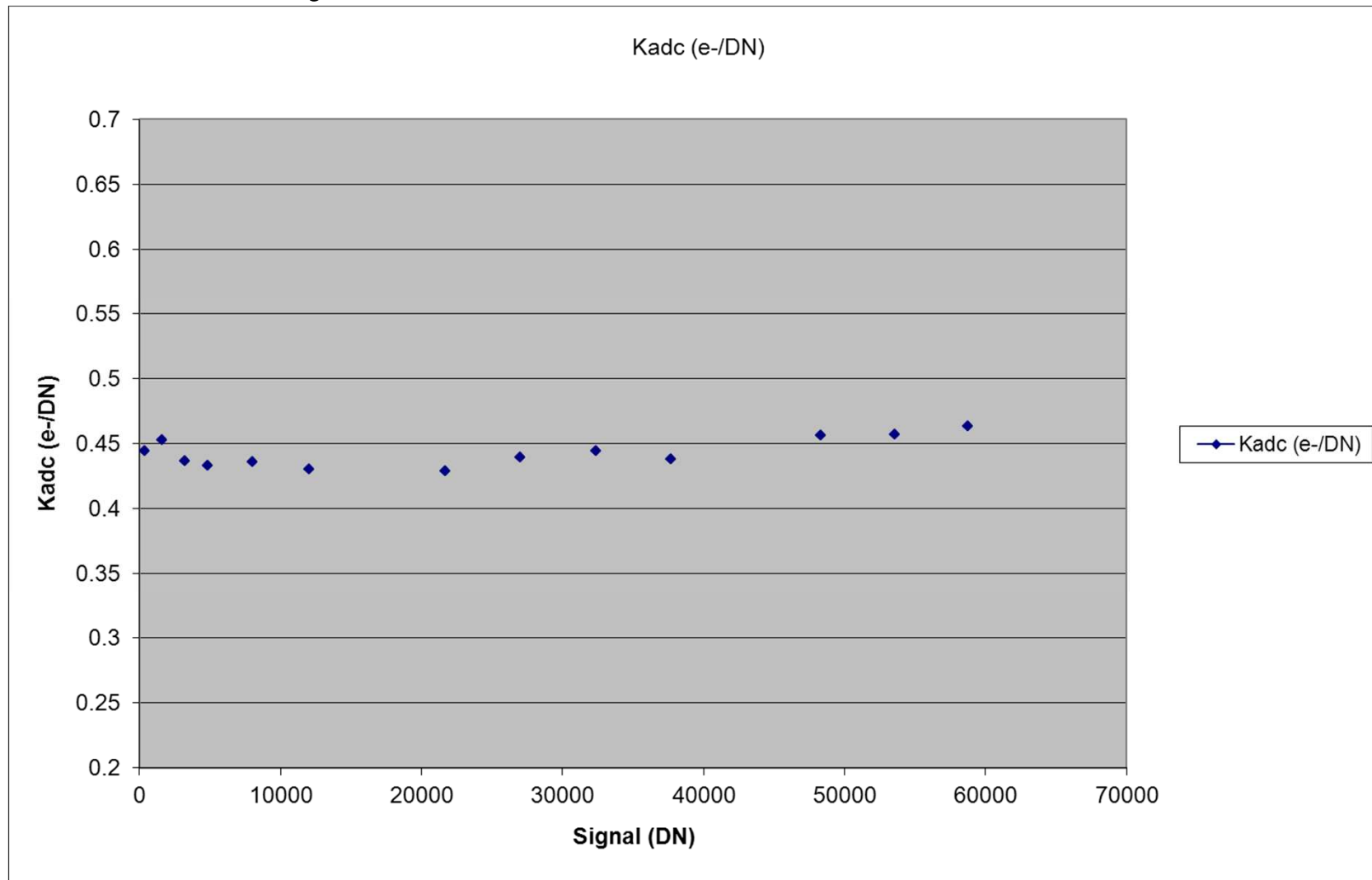

Linearity plot with offset error

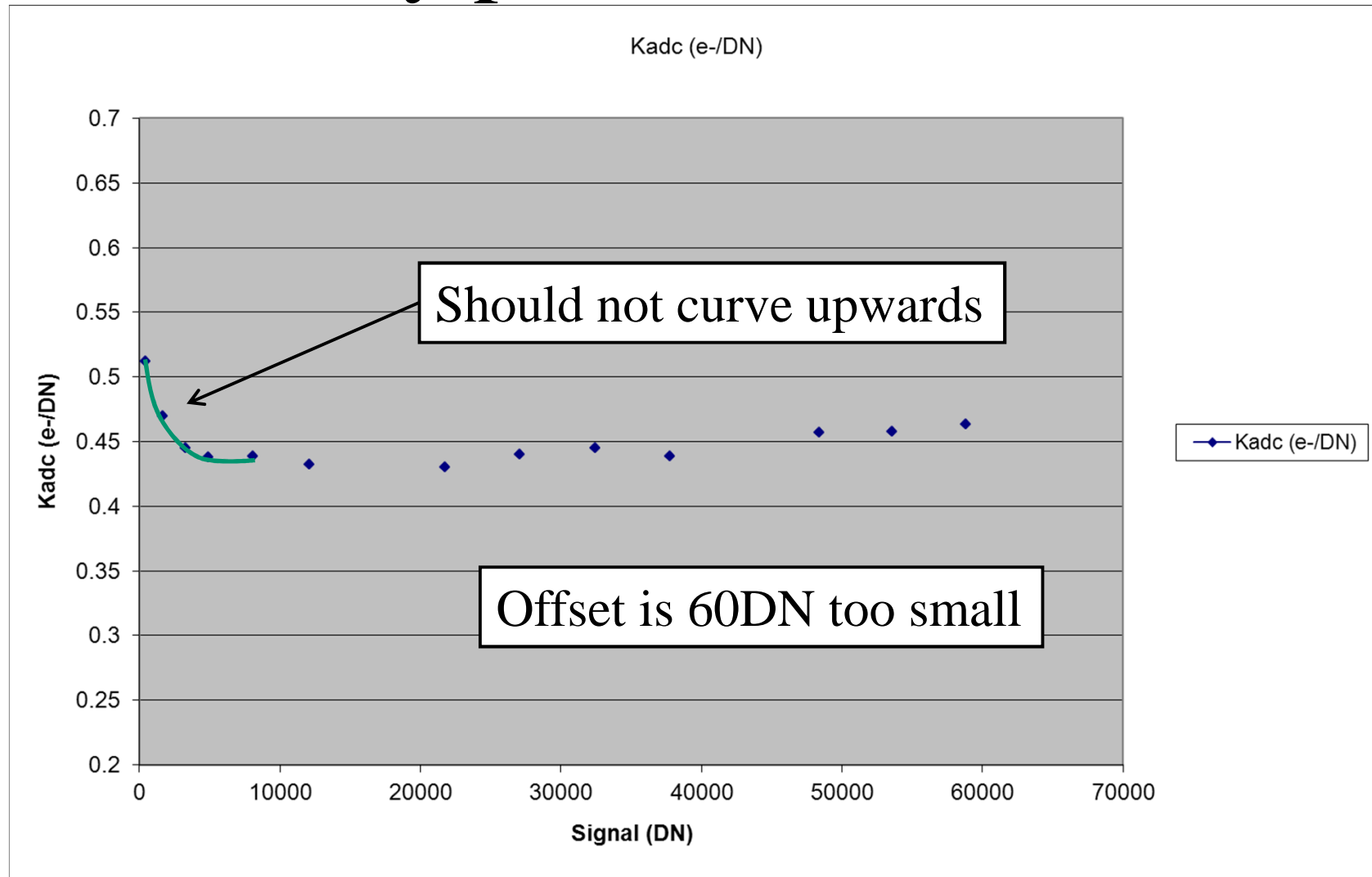

Linearity plot with read noise error

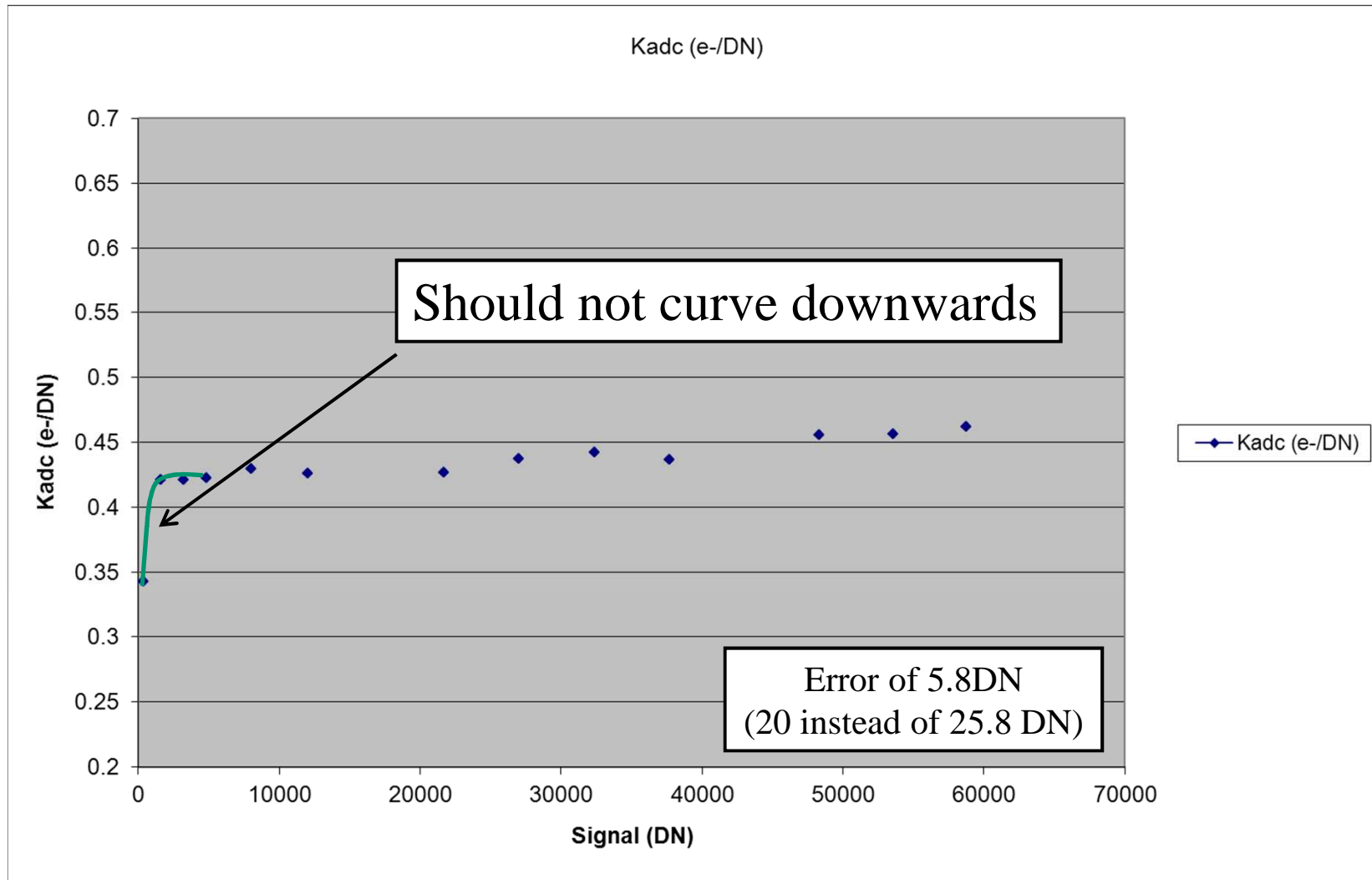

Linearity plot with read noise error

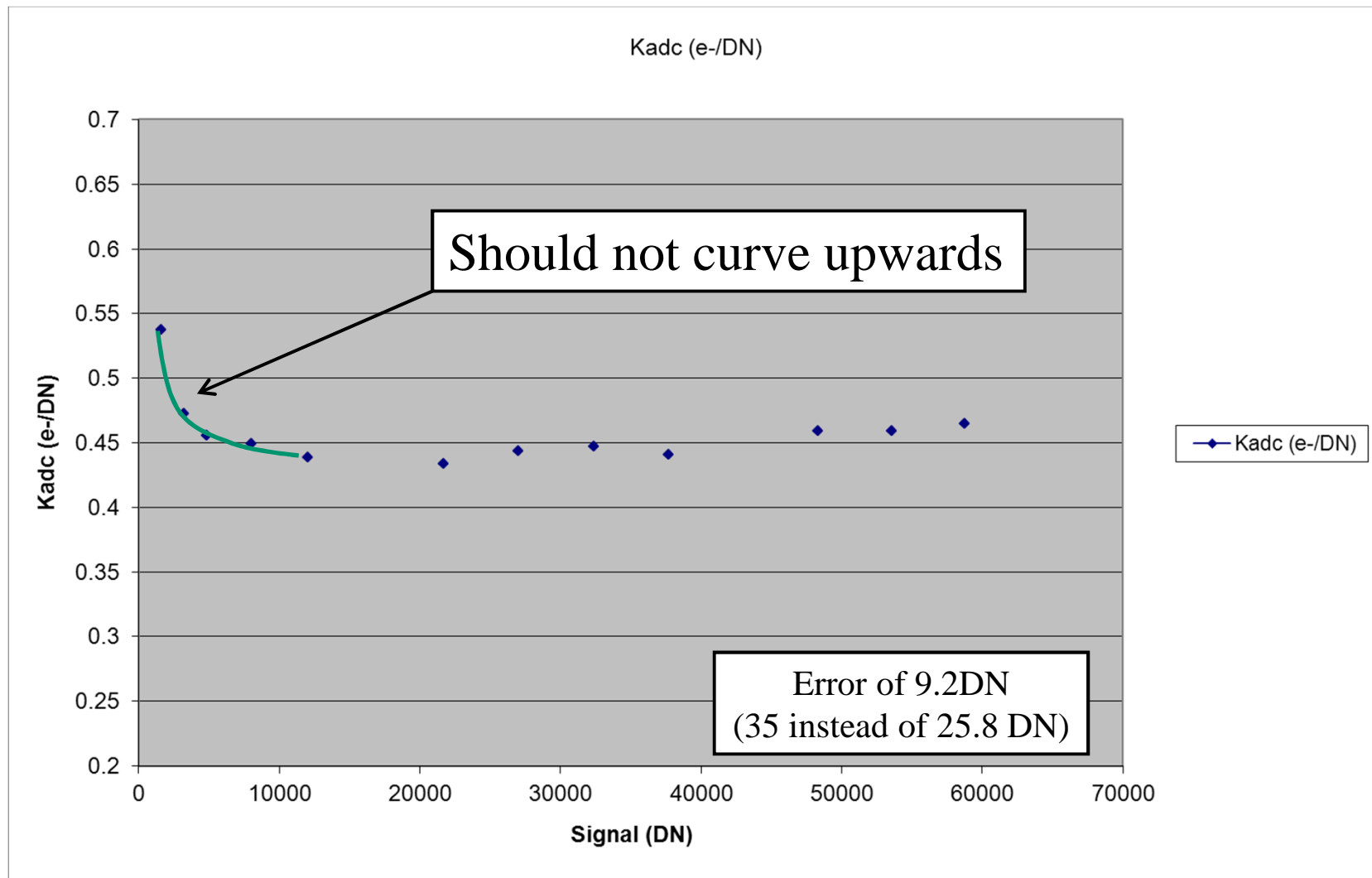

Other types of PTCs

- Many different types of data can be plotted against signal to make different types of PTCs
- One common type is the Flat Field Photon Transfer Curve (“FFPTC”)

FFPTC

- The FFPTC plots noise against signal for flat field data that has been flat-fielded by a master flat. These are useful to gauge the efficacy of a flat-fielding protocol under development
- For example you can test a proposed set of flats before using them. You can measure the difference in combining 10 versus 25 flats for example

Making a FFPTC

- Slight difference in data collection:
 - Take this data set using your focused optics
 - Take set of flats as you would use for normal calibrations
 - Then shoot a set of exposures (flat field) starting from minimum and keep doubling exposure time until full well is reached
 - Iterate around full well if desired or skip this part
 - No need to take pairs of exposures, single exposures at each point are all that are needed
- Data reduction:
 - Measure offset and subtract from calibration flats
 - Make multiple calibration flat masters: zero frames, 1 frame, 5 frames, 10 frames, 25 frames combined for example
 - Measure and subtract offset from each exposure frame then apply flat field to each
 - Measure average value and standard deviation of each calibrated exposure and plot

FFPTC

Shows Noise versus Signal for a variety of electron-counts in the flat field master set

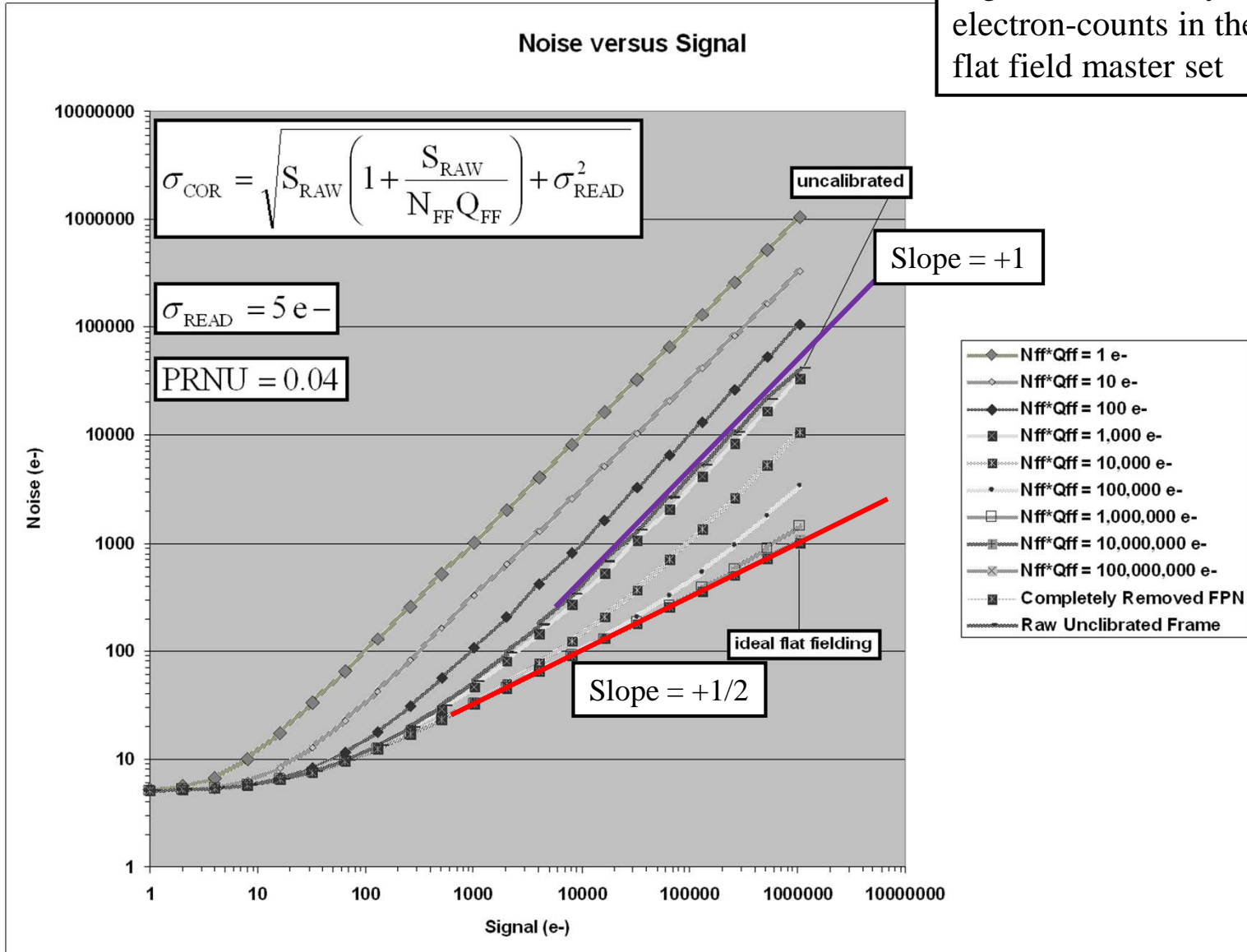

FFPTC used with heavily vignettted optics

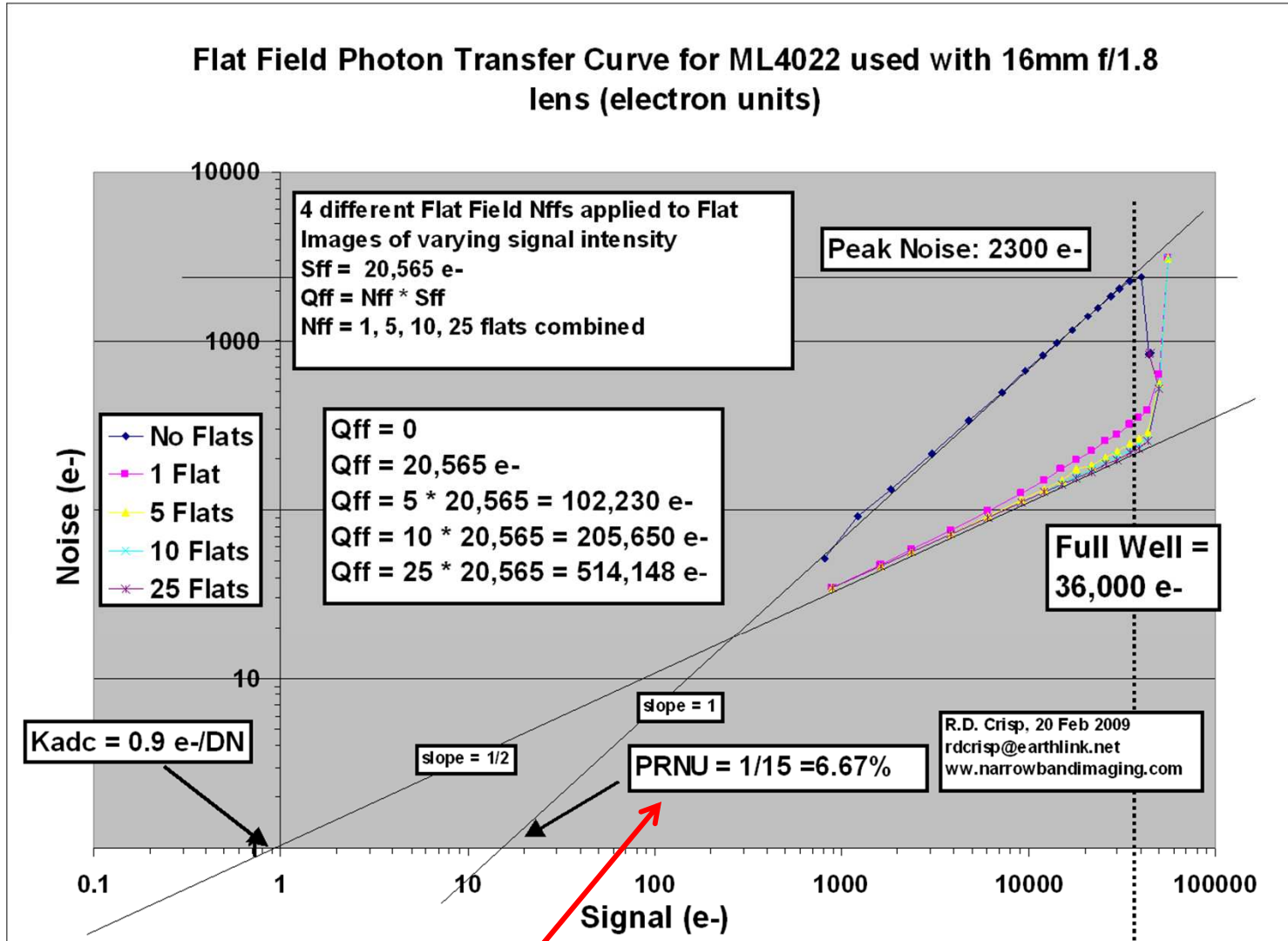

PRNU is very high due to optical vignetting

Heavy vignetting: High system-level PRNU

16mm f/1.8

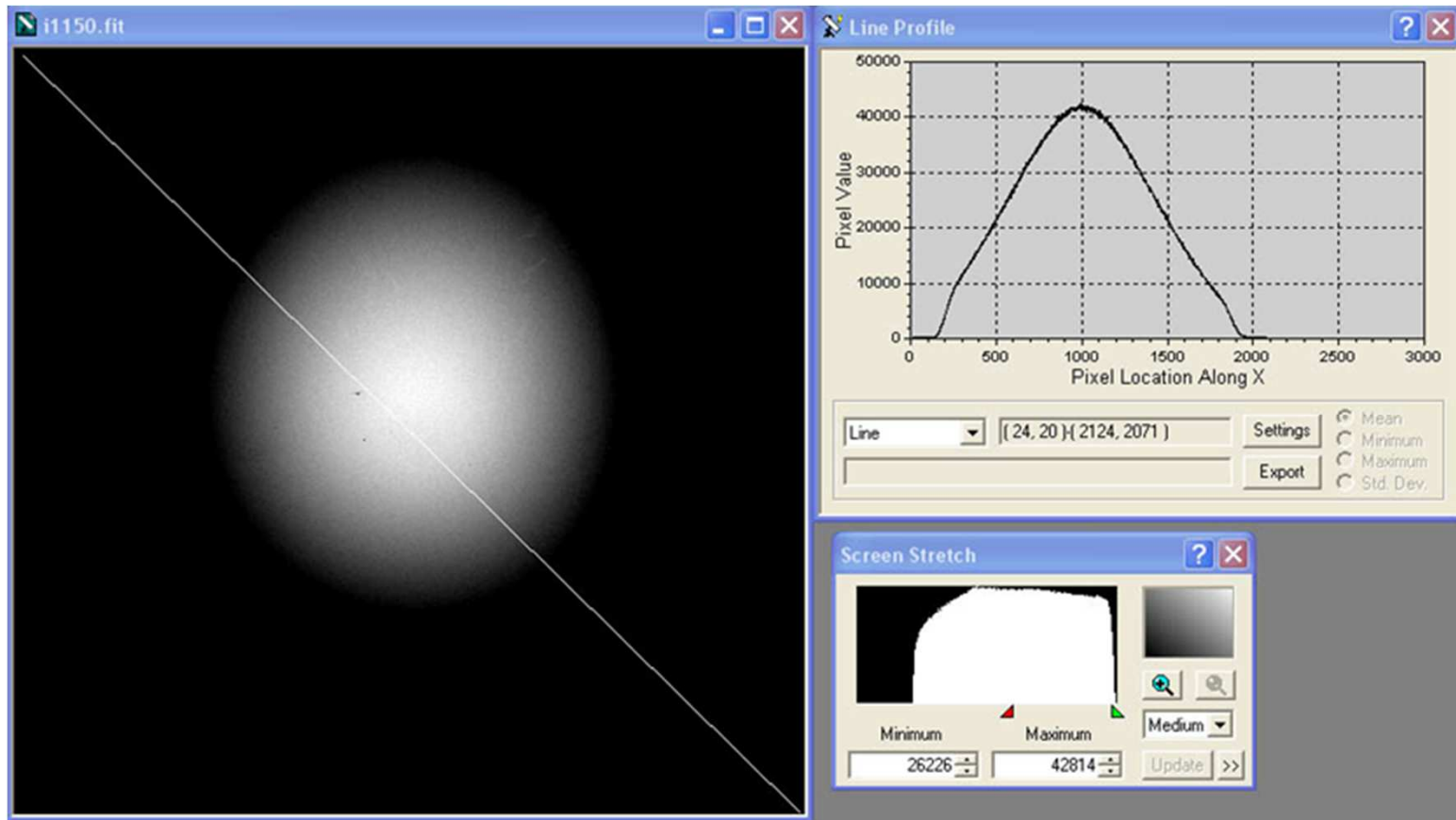

FFPTC used with non-vignetted optics

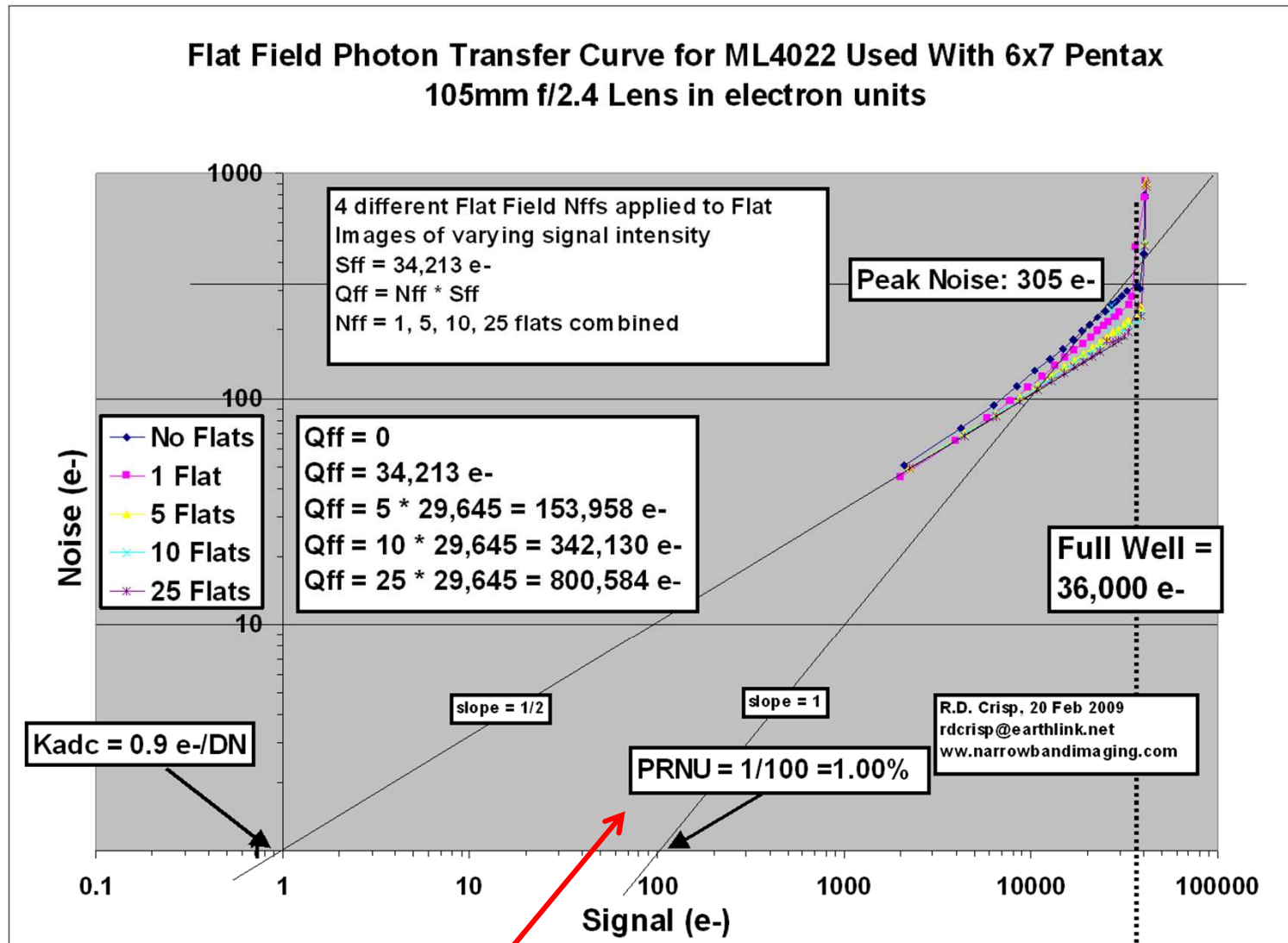

PRNU is in normal range of sensor due to non-vignetted optics

Low vignetting: Low system-level PRNU

Pentax 6x7 105mm f/2.4

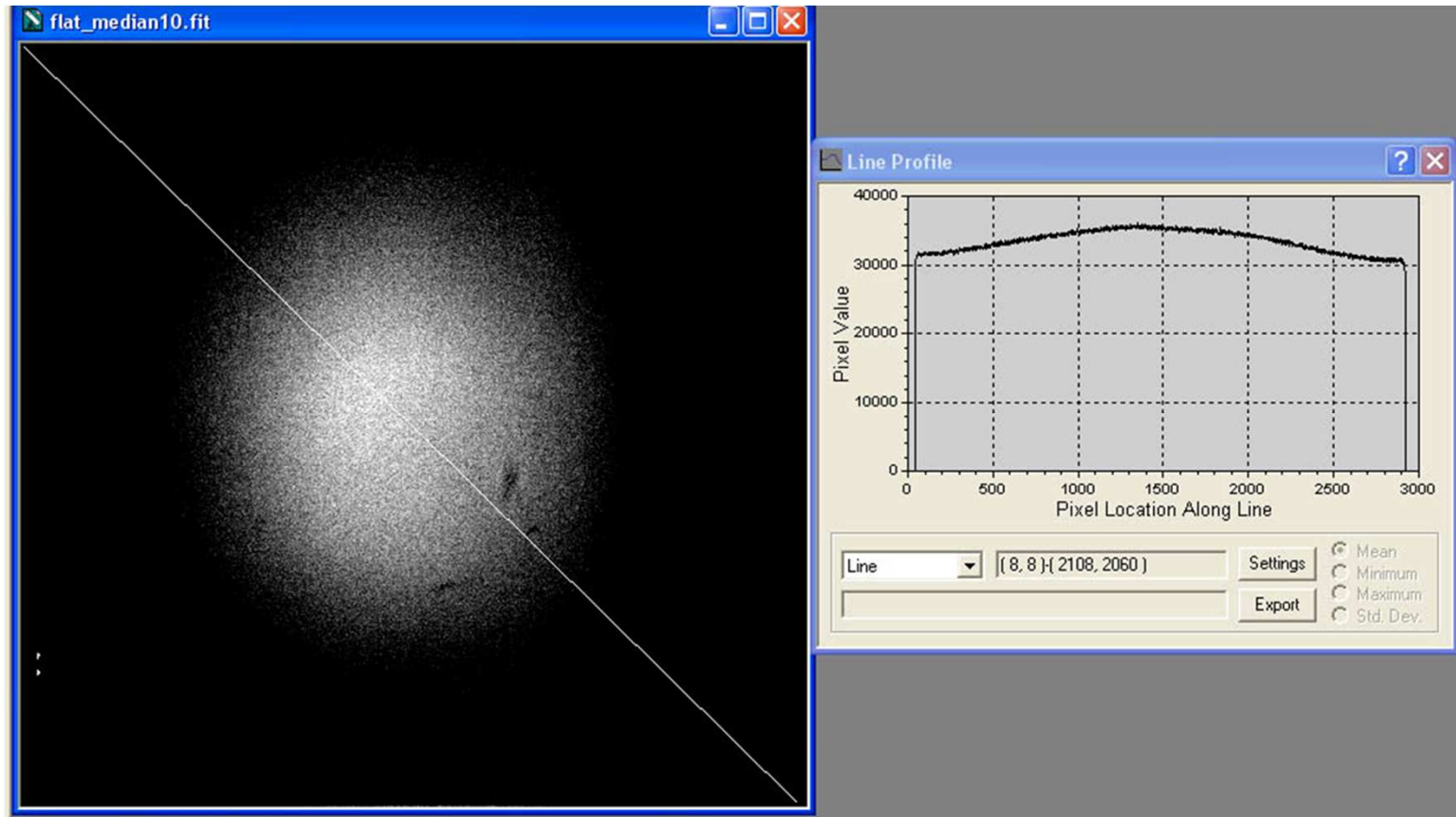

Part 3: Flat Fielding Basic Concepts

- What is Flat Fielding and how does it work?
- What will it correct and what will it not correct?
- How do you know what level to shoot for a flat?
- How do you know how many flats to shoot?
- How can you measure how well the flats are working?
- How can you determine the total signal needed in the set of flats (signal level * number of flats)?

What is flat fielding?

- Flat-fielding is a process used to remove FPN from an image
- Unless the FPN is removed from the image, it will place an upper limit on the maximum possible Signal to Noise Ratio (“SNR”)
- Flat fielding is performed by dividing an image by a “flat-field” image on a pixel by pixel basis
- The flat-field image is an image of a featureless background. This image reveals the non-uniformities of the combination of the optics and camera’s sensor which appear in every image taken by the system.

How does FPN limit the SNR?

Neglecting dark current sources, the noise in an image is expressed by the familiar noise equation:

$$\text{Noise}_{\text{IMAGE}} = \sqrt{\text{Signal_shot_noise}^2 + \text{Fixed_pattern_noise}^2 + \text{Read_noise}^2}$$

recall: $\text{Signal_shot_noise} = \sqrt{\text{Signal}}$

$$\text{Fixed_pattern_noise} = \text{PRNU} * \text{Signal}$$

Substituting, we get:

$$\text{Noise}_{\text{IMAGE}} = \sqrt{\text{Signal} + (\text{Signal} * \text{PRNU})^2 + \text{Read_Noise}^2}$$

How does FPN limit the SNR cont'd

$$\text{Signal/Noise}_{\text{IMAGE}} = \text{Signal} / \sqrt{\text{Signal} + (\text{Signal} * \text{PRNU})^2 + \text{Read_Noise}^2}$$

$$\text{When: } \text{Signal} \geq \frac{1}{\text{PRNU}^2}$$

$$\text{Signal/Noise}_{\text{IMAGE}} \leq 1 / \text{PRNU}$$

This establishes a ceiling on our Signal/Noise ratio which is bad

So we will use flat-fielding to eliminate the FPN term in the noise equation

The flat fielding operation

The flat fielding operation consists of dividing, pixel by pixel, the raw image by a flat field image. The corrected i th pixel of an image that has been flat-fielded is expressed as:

$$S_{\text{COR}_i} = \mu_{\text{FF}} \frac{S_{\text{RAW}_i}}{S_{\text{FF}_i}} \quad (1)$$

S_{COR_i} = corrected signal

S_{FF_i} = signal in flat field

S_{RAW_i} = signal in raw image

μ_{FF} = average signal level in flat field

Noise in a flat-fielded image

In order to test the efficacy of the flat-fielding operation, we need to know the noise of this corrected image. We now seek the equation for the noise of the corrected image in terms of the signal level in the flat field and the raw images.

Since the noise of the corrected image is simply the square root of the variance of the image we can calculate the variance.

The corrected image is a function of two variables, the raw signal and the flat field signal. To calculate the variance of a function of two variables where the variables are uncorrelated, we use the simplified propagation of errors formula:

$$\sigma_Q^2 = \sigma_x^2 \left(\frac{\partial Q}{\partial x} \right)^2 + \sigma_y^2 \left(\frac{\partial Q}{\partial y} \right)^2 \quad (2)$$

Noise in a flat-fielded image cont'd

Applying (2) to (1) and including a read noise term for a practical system we get

$$\sigma_{\text{COR}}^2 = \sigma_{\text{FF-shot}}^2 \left(\frac{\partial S_{\text{COR}}}{\partial S_{\text{FF}}} \right)^2 + \sigma_{\text{RAW-shot}}^2 \left(\frac{\partial S_{\text{COR}}}{\partial S_{\text{RAW}}} \right)^2 + \sigma_{\text{READ}}^2 \quad (3)$$

Performing the differentiation and doing a lot of manipulation while substituting

$$\sigma_{\text{FF-shot}}^2 = S_{\text{FF}}$$

$$\sigma_{\text{RAW-shot}}^2 = S_{\text{RAW}}$$

equation (3) simplifies to

$$\sigma_{\text{COR}}^2 = S_{\text{RAW}} \left(1 + \frac{S_{\text{RAW}}}{S_{\text{FF}}} \right) + \sigma_{\text{READ}}^2 \quad (4)$$

How it works

$$\sigma_{\text{COR}}^2 = S_{\text{RAW}} \left(1 + \frac{S_{\text{RAW}}}{S_{\text{FF}}} \right) + \sigma_{\text{READ}}^2 \quad (4)$$

so long as $S_{\text{FF}} \gg S_{\text{RAW}}$ equation (4) reduces to

$$\sigma_{\text{COR}}^2 = S_{\text{RAW}} + \sigma_{\text{READ}}^2$$

which is shot noise limited when $S_{\text{RAW}} > \sigma_{\text{READ}}^2$

indicating the Fixed Pattern Noise is completely removed thereby meeting our goal

One remaining issue related to finite well depth

Unfortunately with a finite well depth the inequality $S_{\text{FF}} \gg S_{\text{RAW}}$ cannot always be guaranteed when using a single flat field frame to calibrate a raw image containing a high signal level. A solution can be found by averaging N_{FF} frames of signal level S_{FF}

$$\sigma_{\text{COR}}^2 = S_{\text{RAW}} \left(1 + \frac{S_{\text{RAW}}}{N_{\text{FF}} S_{\text{FF}}} \right) + \sigma_{\text{READ}}^2 \quad (5)$$

Solving the finite well depth issue

Since any arbitrary number of flat field images can be combined together, it is a simple matter to guarantee $N_{FF} S_{FF} \gg S_{RAW}$ by selecting an appropriate value of N_{FF} and S_{FF} such that (5) simplifies to

$$\sigma_{COR}^2 = S_{RAW} + \sigma_{READ}^2 \quad (6)$$

Taking the square root of each side and substituting descriptive names for the variables (6) transforms into our desired noise equation, which is free of the SNR-limiting FPN term

$$\text{Noise}_{IMAGE} = \sqrt{\text{Signal} + \text{Read_noise}^2}$$

What will Flat-Fielding correct and not correct?

- Flat-fielding will correct fixed pattern noise
- Fixed pattern noise is always proportional to signal level: $FPN = PRNU * Signal$
- Flat-fielding will not correct noise that is not proportional to signal level such as saturated pixels, RBI trap non-uniformity, dark spikes, charge “skim” traps, bad columns, dead pixels etc

What about non-linearity and flats?

- There are two types of non-linearity in CCDs and CMOS image sensors:
 - V/V nonlinearity (variation of linearity of output source-follower amplifier)
 - V/e- nonlinearity (variation of capacitance versus voltage of sense node capacitor)
 - For CCDs the V/e- nonlinearity isn't much of a concern due to the comparatively high reverse bias voltage on the sense node capacitor
 - The dC/dV is small with high bias voltages as found in CCDs
- Flat-fielding is applicable in the presence of V/V nonlinearity: no ill effect is observed
- Some remnant FPN results with V/e- nonlinearity

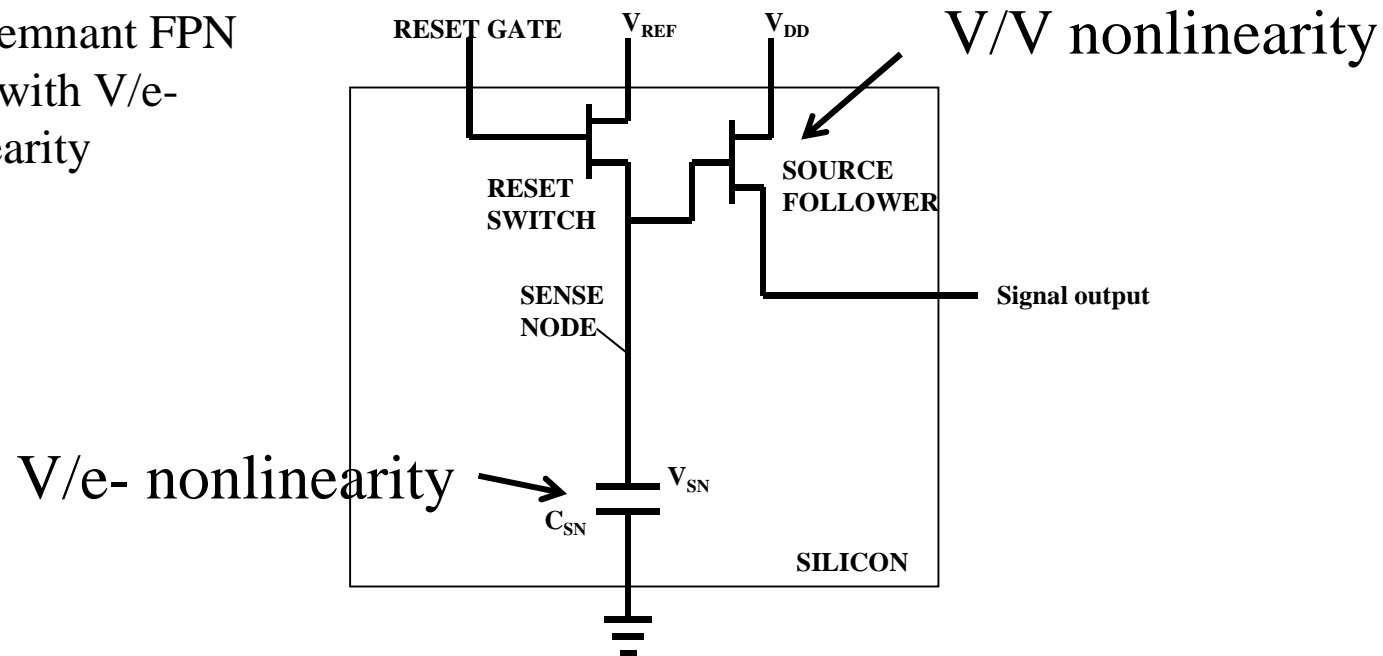

V/V Nonlinearity in a PTC

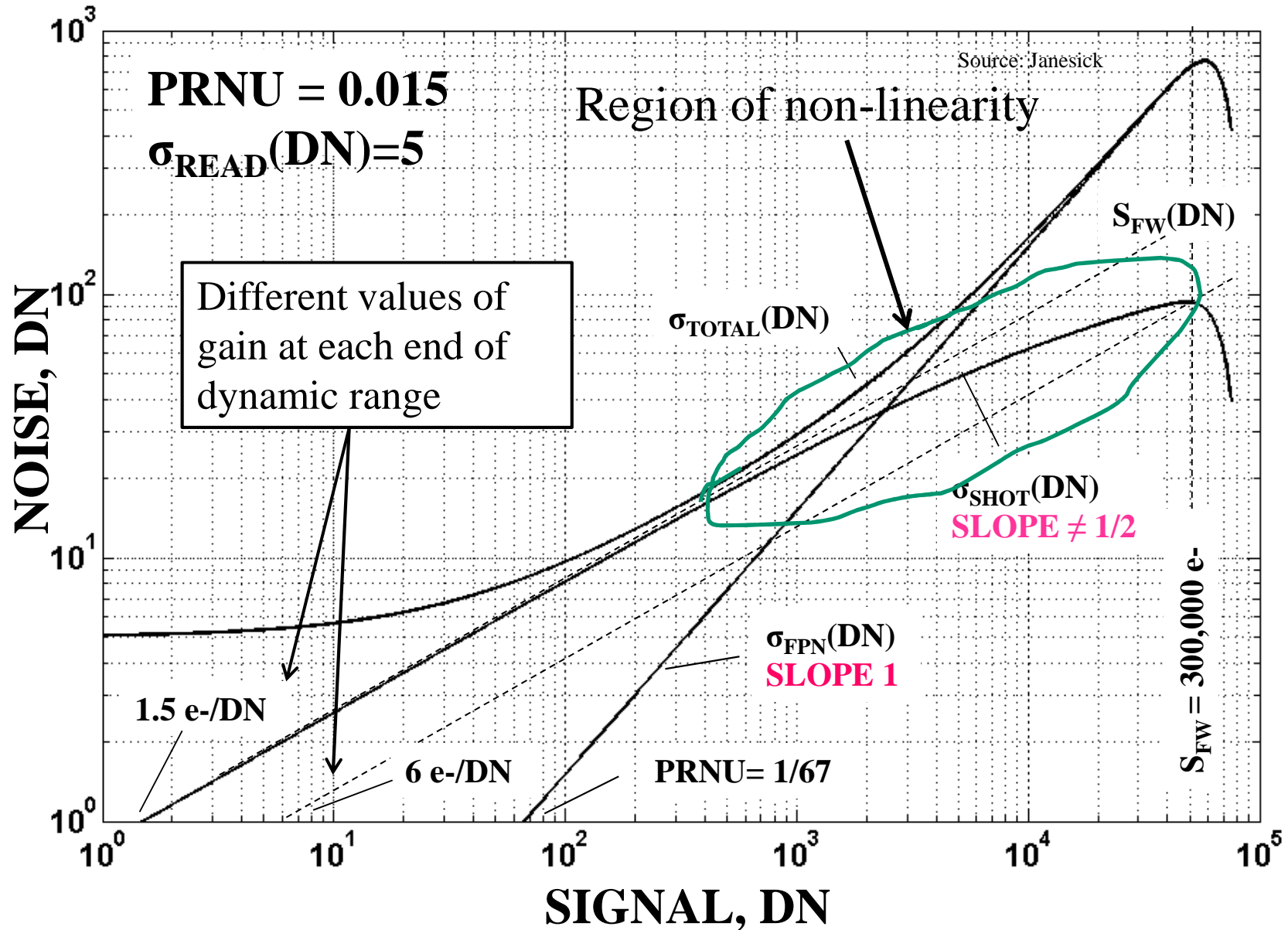

Raw Signal with V/V nonlinearity

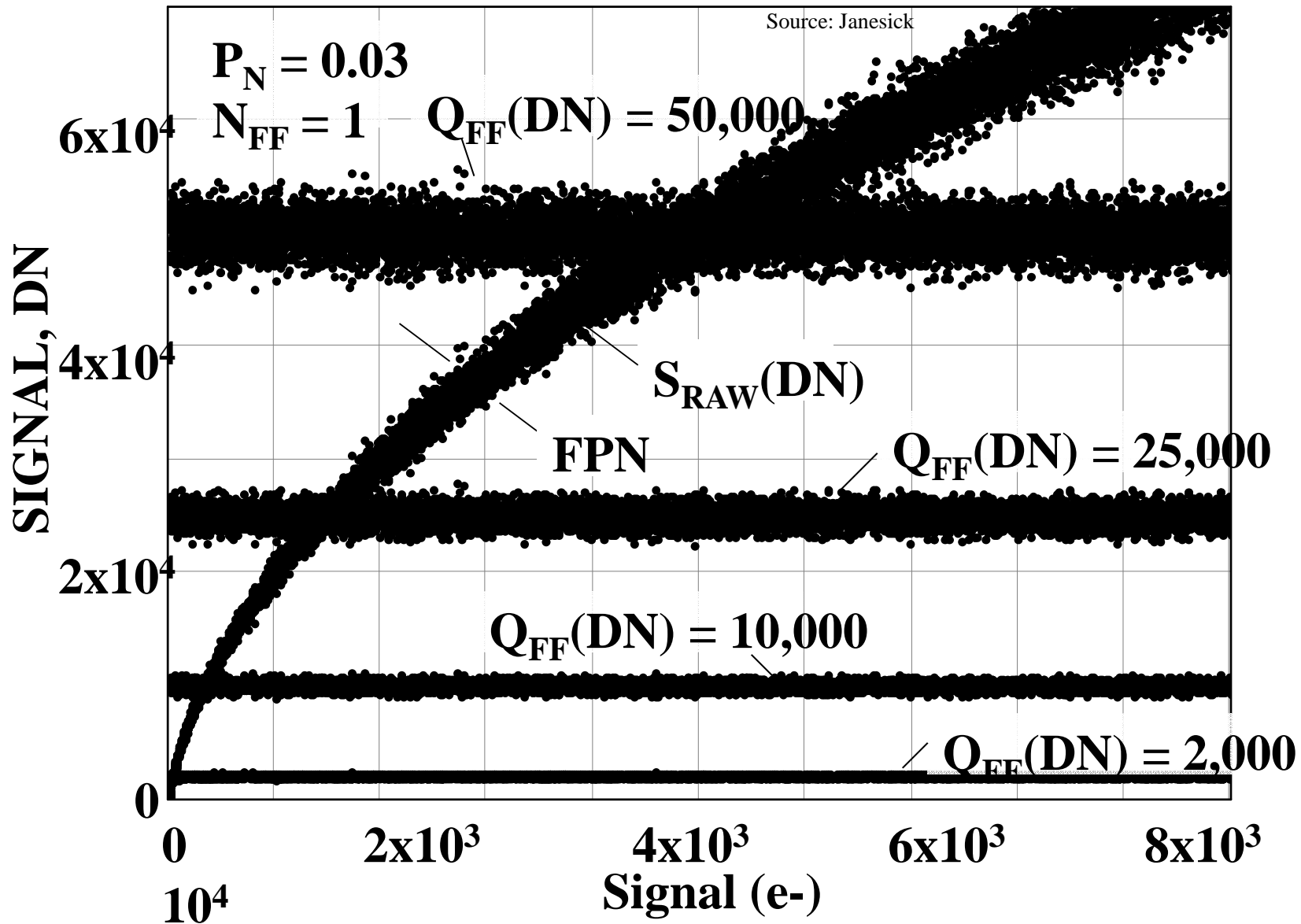

Flat fielding with V/V nonlinearity

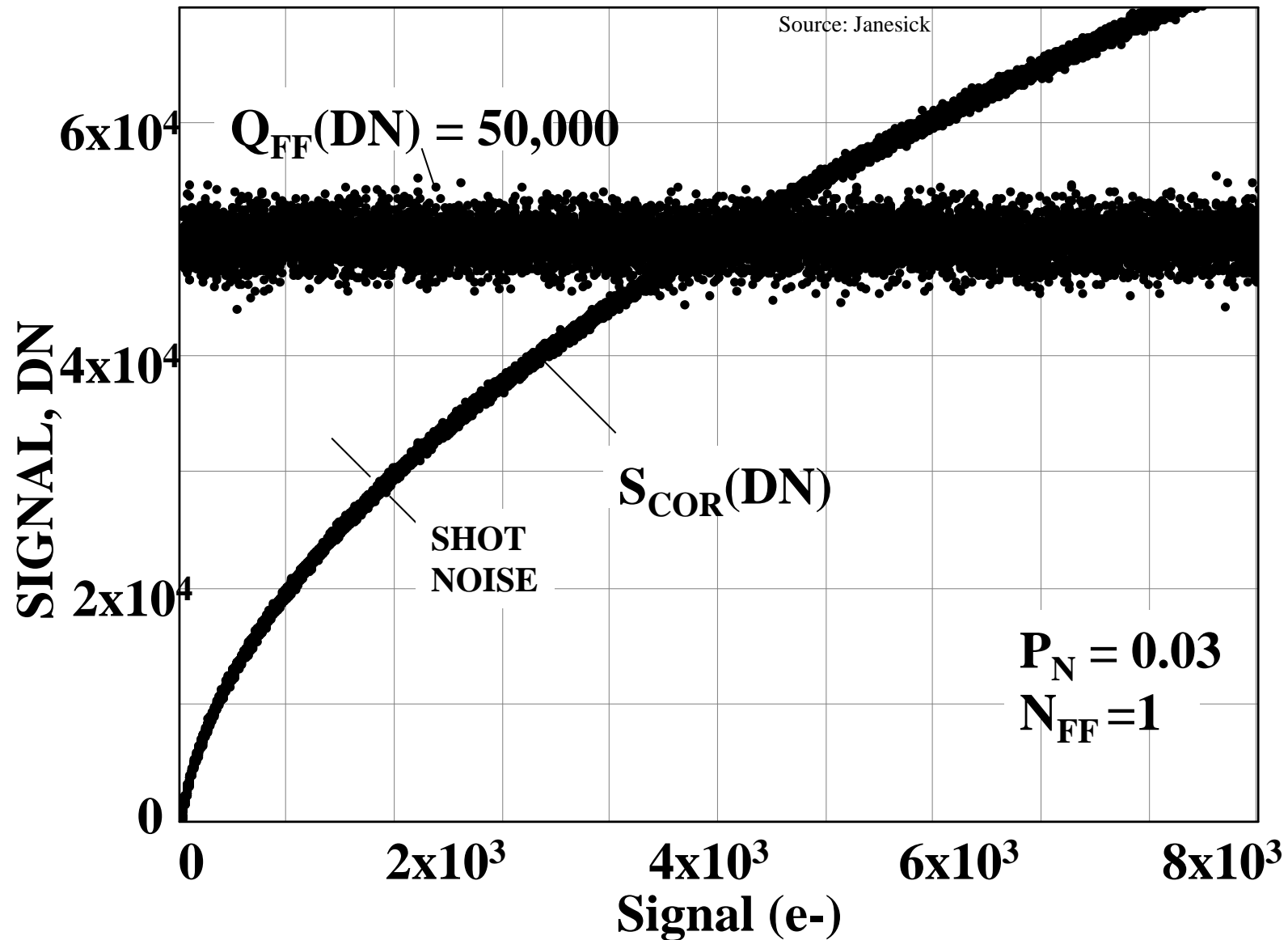

V/e- nonlinearity in a PTC

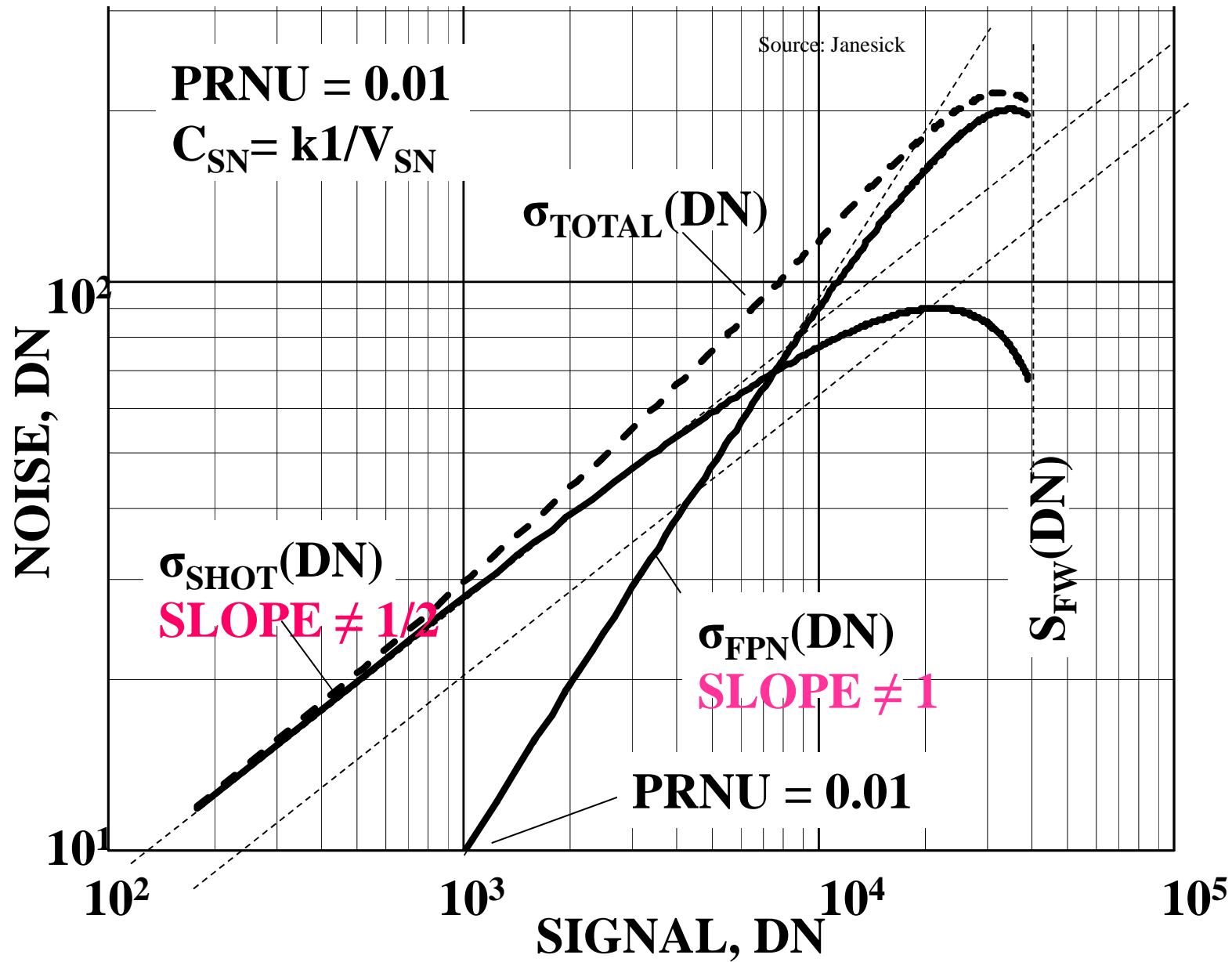

Flat-Fielding with V/e- nonlinearity

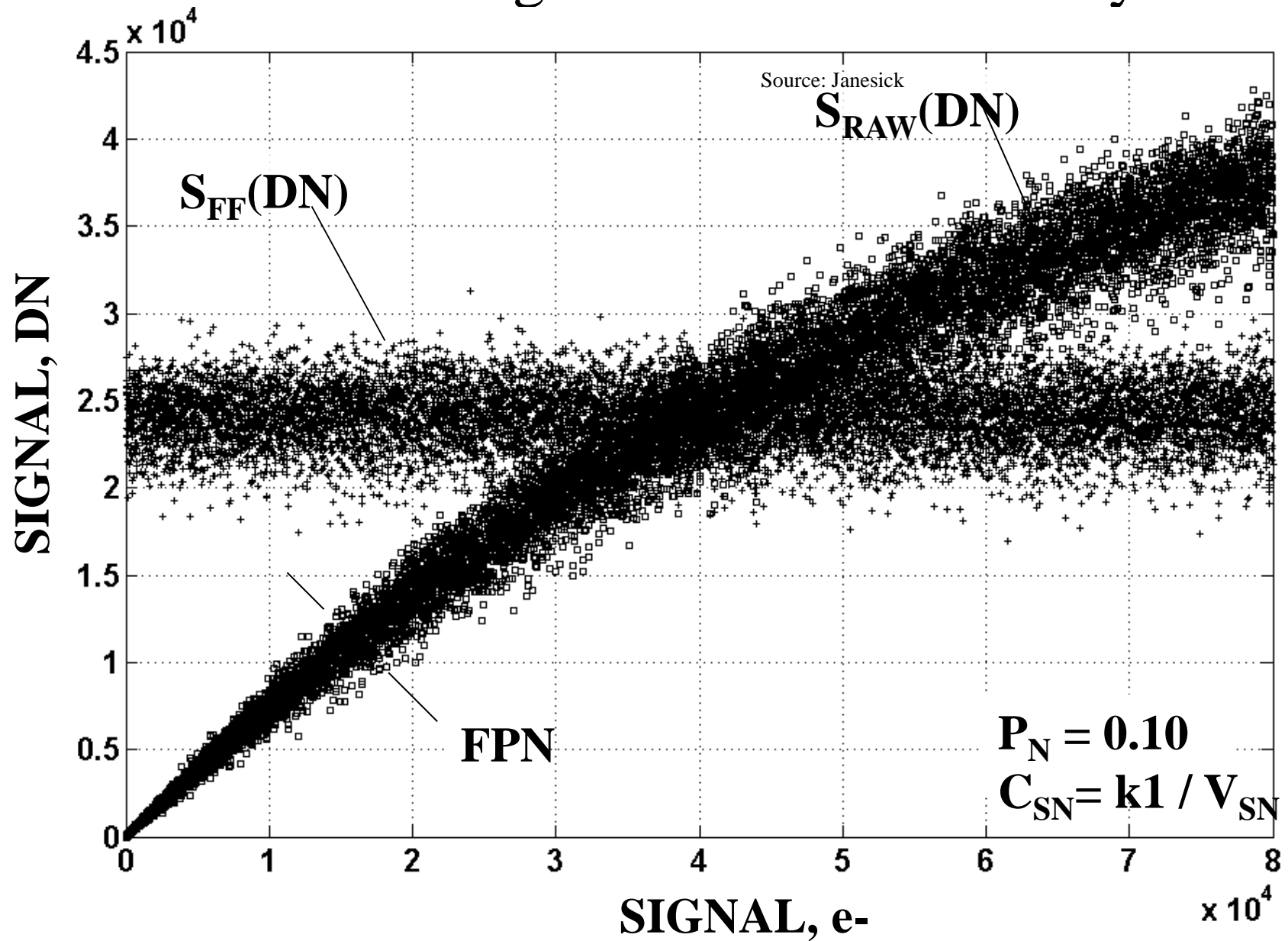

Flat Fielding with V/e- nonlinearity

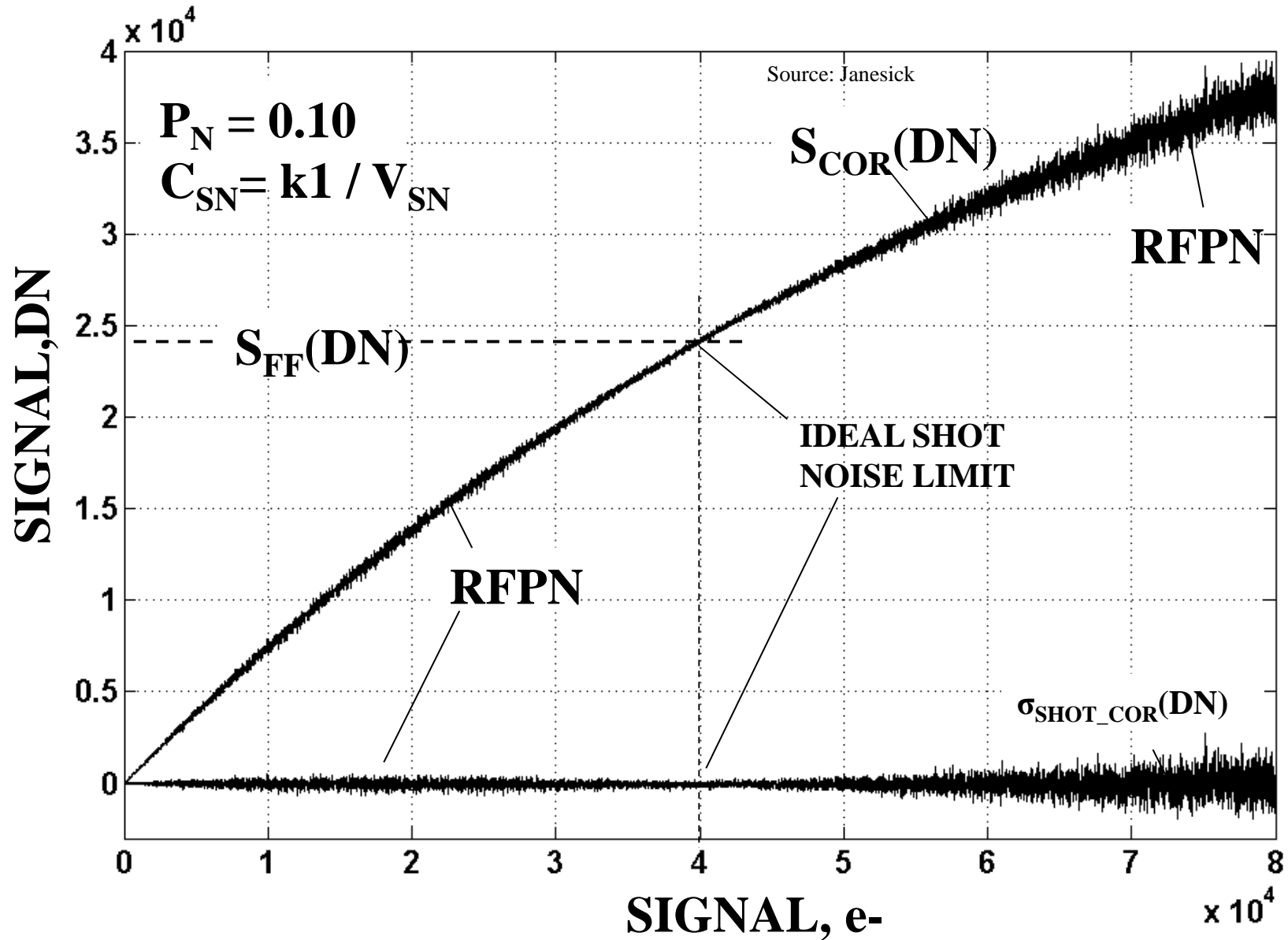

How do you know what signal level to use for the flats?

- As has been shown, signal levels for the flats should be as high as practical to minimize the FPN and to reduce the total number of flats needed (pages 67-68)
- The signal level should be high enough so that read noise is inconsequential;
 - ex: $10e^-$ read noise = shot noise of $100e^-$ signal
 - To be inconsequential, should be less than 1-2%: signal levels
 - Signal level at least 10,000 e^- or more for $10e^-$ read noise camera
- The signal level should be low enough so that no pixels saturate
- SNR of Flat is proportional to $\text{SQRT}(\#\text{Frames})$ and proportional to $\text{SQRT}(\text{signal level in frame})$.
- Easier to get a good “image” of the FPN if the camera is operated in the FPN-Limited region: fewer flats, high signal level

Signal level in flats cont'd (high PRNU case)

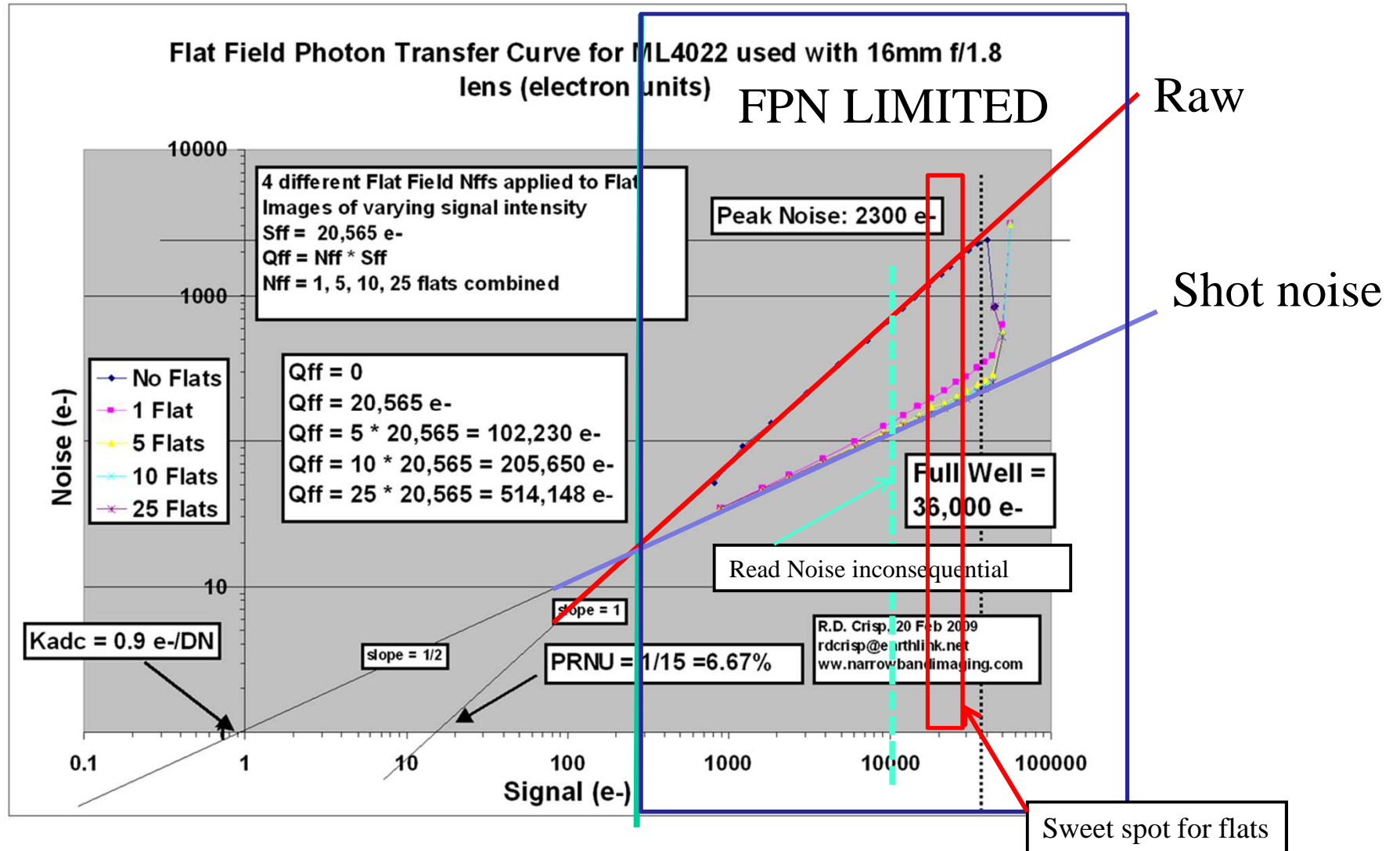

Signal level in flats cont'd (low PRNU case) **FPN LIMITED**

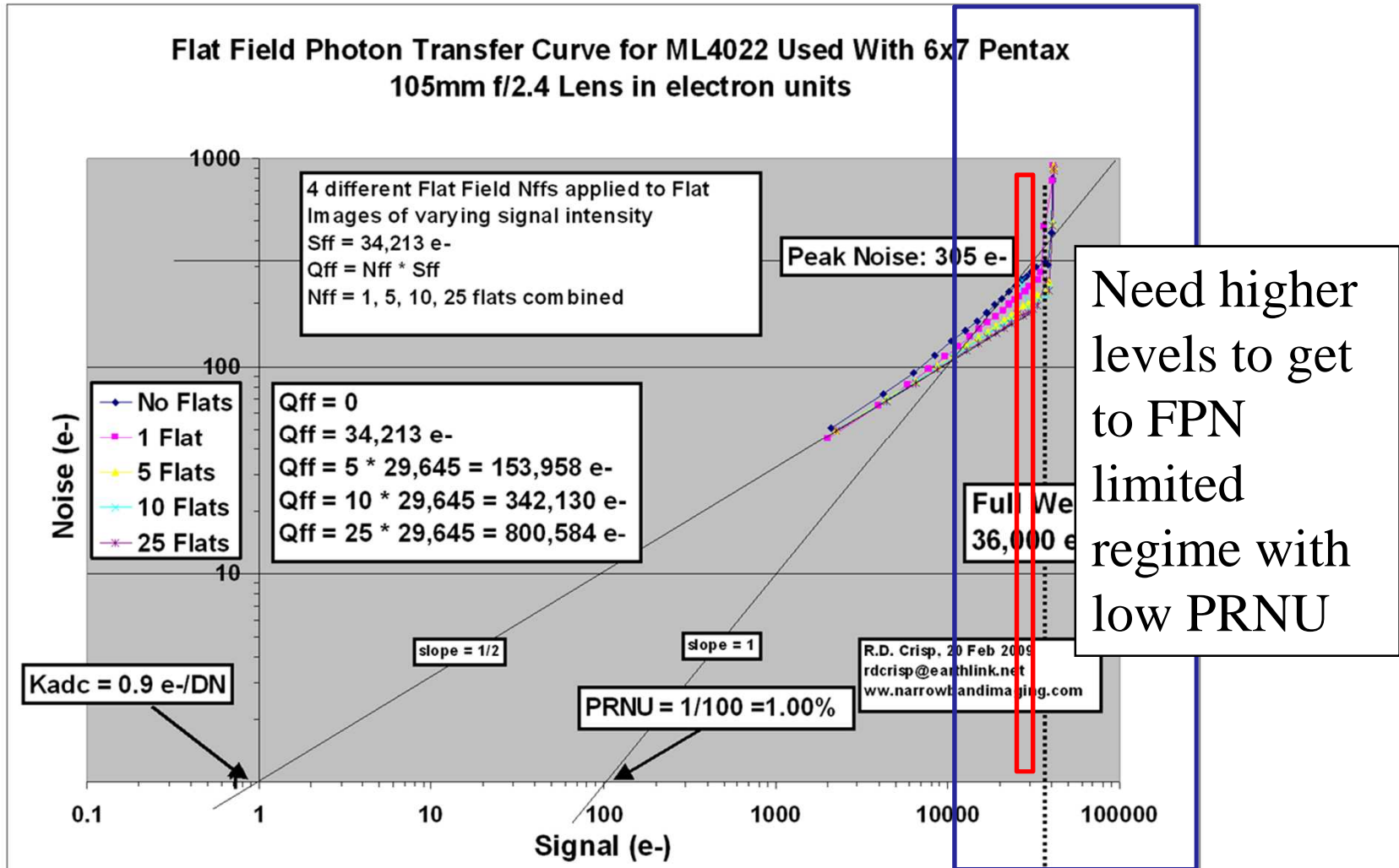

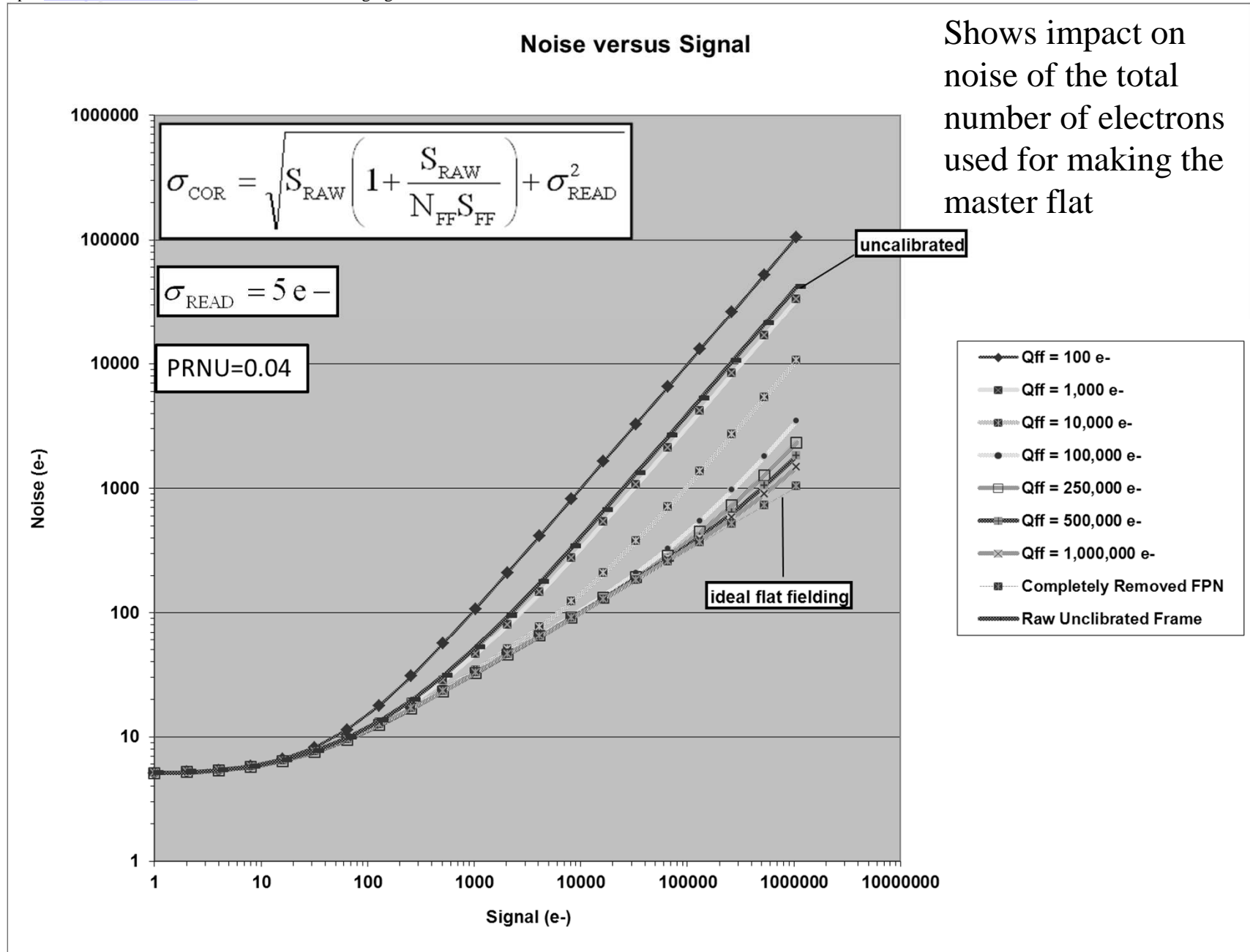

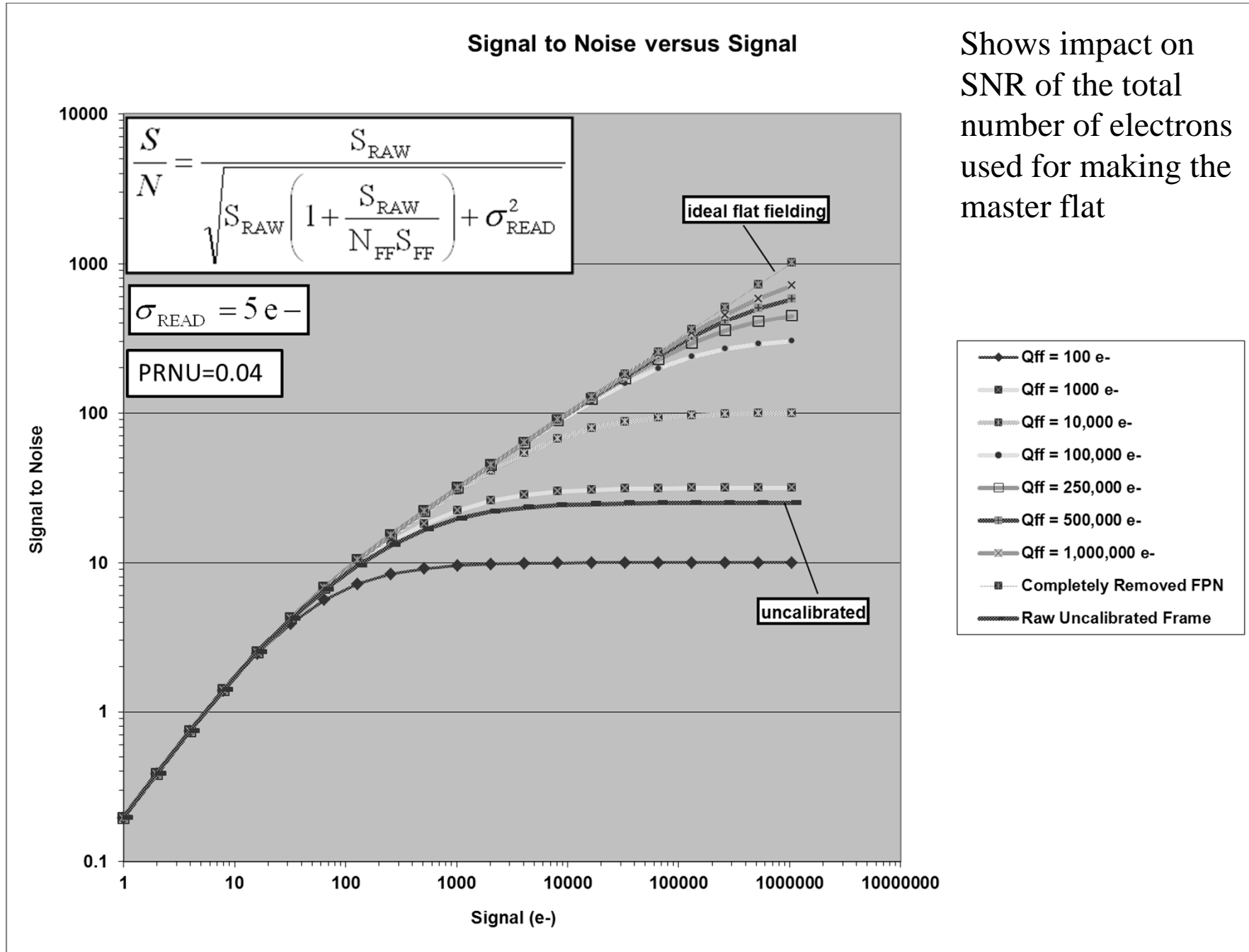

Testing Master Flat

- Once you have prepared a master flat, you can test it by making a FFPTC (flat field photon transfer curve: explained in part 2)
- If the slope of the FFPTC is $+1/2$ then the FPN is completely removed

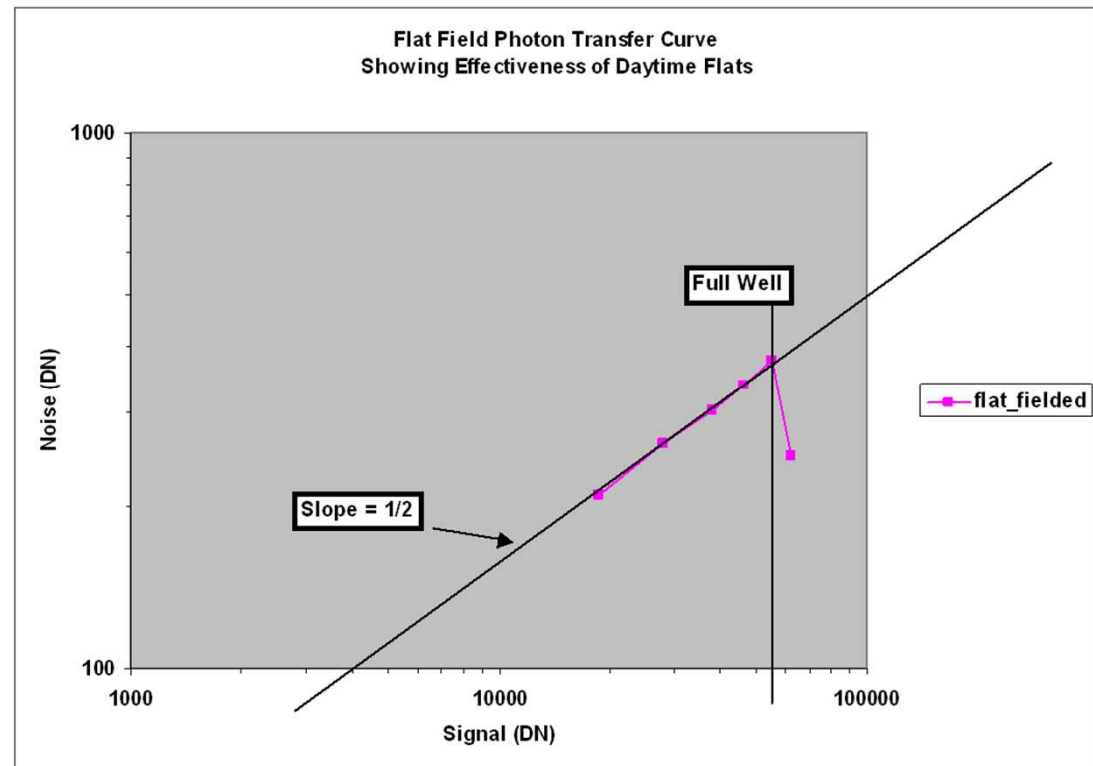
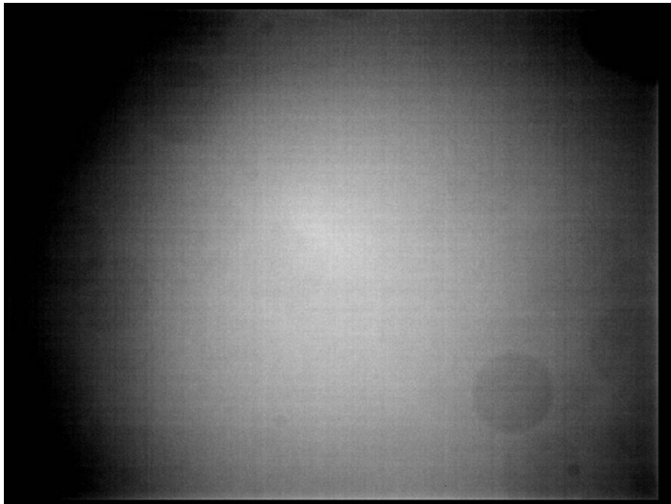

FFPTC: How many flats is enough?

- You can also combine varying numbers of the flat frames to make several master flats and test each on the same set of FFPTC raw data to see how many flats are actually necessary to reach a given performance level

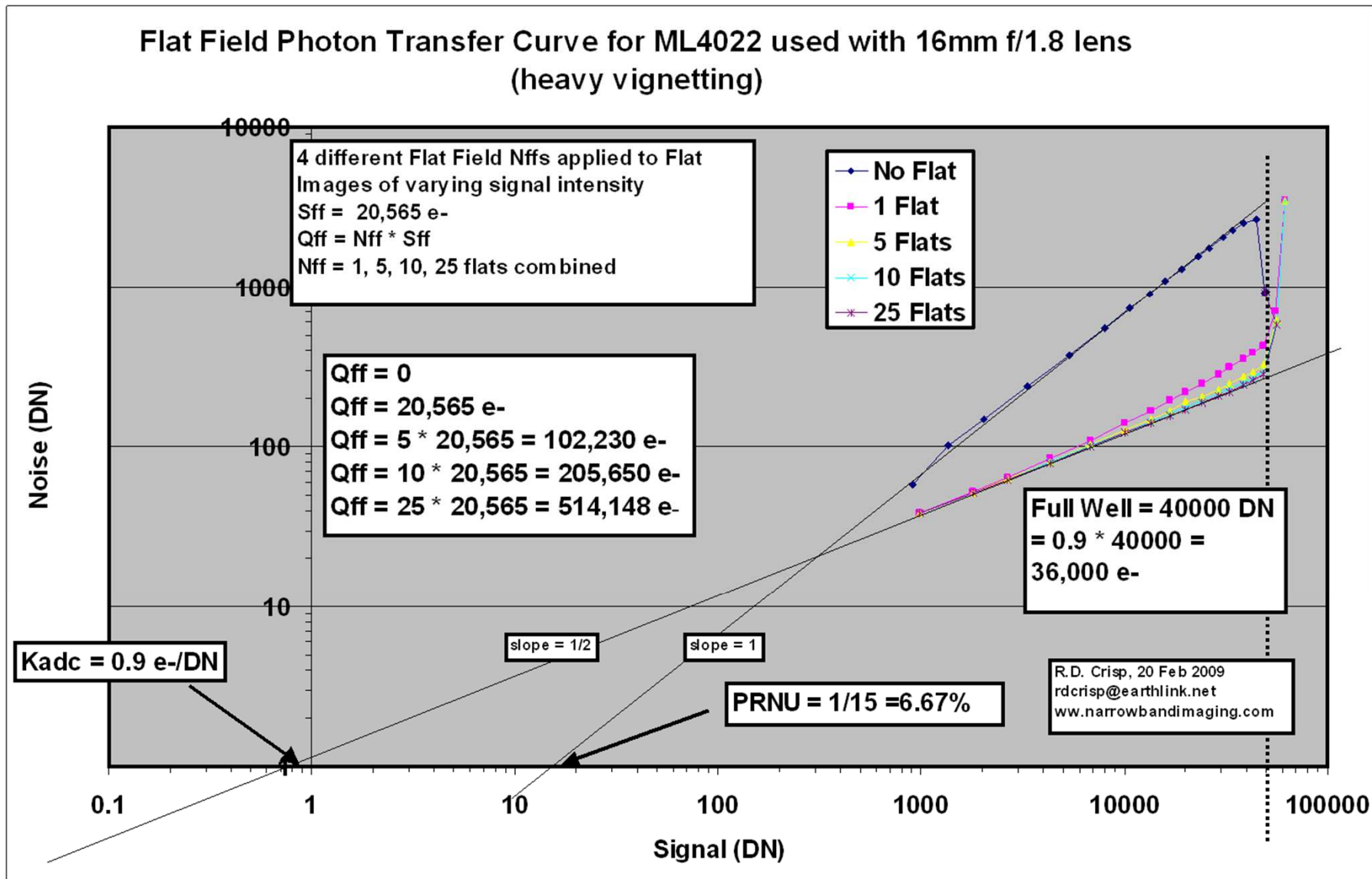

For modest signal levels, 5-10 frames seems sufficient for this system

Total Signal Level for “breakeven”

- When a flat is used to flat-field another flat of equal signal level, the shot noise in the resulting image is increased by $\text{SQRT}(2)$
- If the noise (electron units) of the flat-fielded image is set to be equal to the noise of the non-flat-fielded image the “breakeven” level of signal (electrons) in the flat field dataset is determined in terms of PRNU (see next page):
 - For the dataset used for the master flat, we can determine the minimum amount of signal needed to prevent increasing the noise after flat-fielding
 - If the signal is less than this minimum, flat-fielding will increase the noise in the image: this is counter to the purpose of flat-fielding

Breakeven signal level

$$\text{Noise}_{\text{IMAGE}} = \sqrt{\text{Signal} + (\text{Signal} * \text{PRNU})^2 + \text{Read_Noise}^2} = \sqrt{\text{Signal} \left(1 + \frac{\text{Signal}}{Q_{\text{FF}}} \right) + \text{Read_Noise}^2}$$

Solving for Q_{FF} 

$$Q_{\text{FF}_{\text{Breakeven}}} = \frac{1}{\text{PRNU}^2}$$

This says that as PRNU increases, the minimum number of electrons needed in the flat field set to avoid increasing noise, drops.

Ie: the noisier is the raw image, so the noisier can be the flat without increasing the noise in the calibrated image

Observing PRNU vs Qff effect

- The next slides will show simulated FFPTCs for varying PRNU values ranging from 0.5 to 0.001
- Observe how the “uncalibrated” curve moves to progressively higher numbers of electrons needed in the flat-field set to match the “uncalibrated” curve

PRNU = 0.50

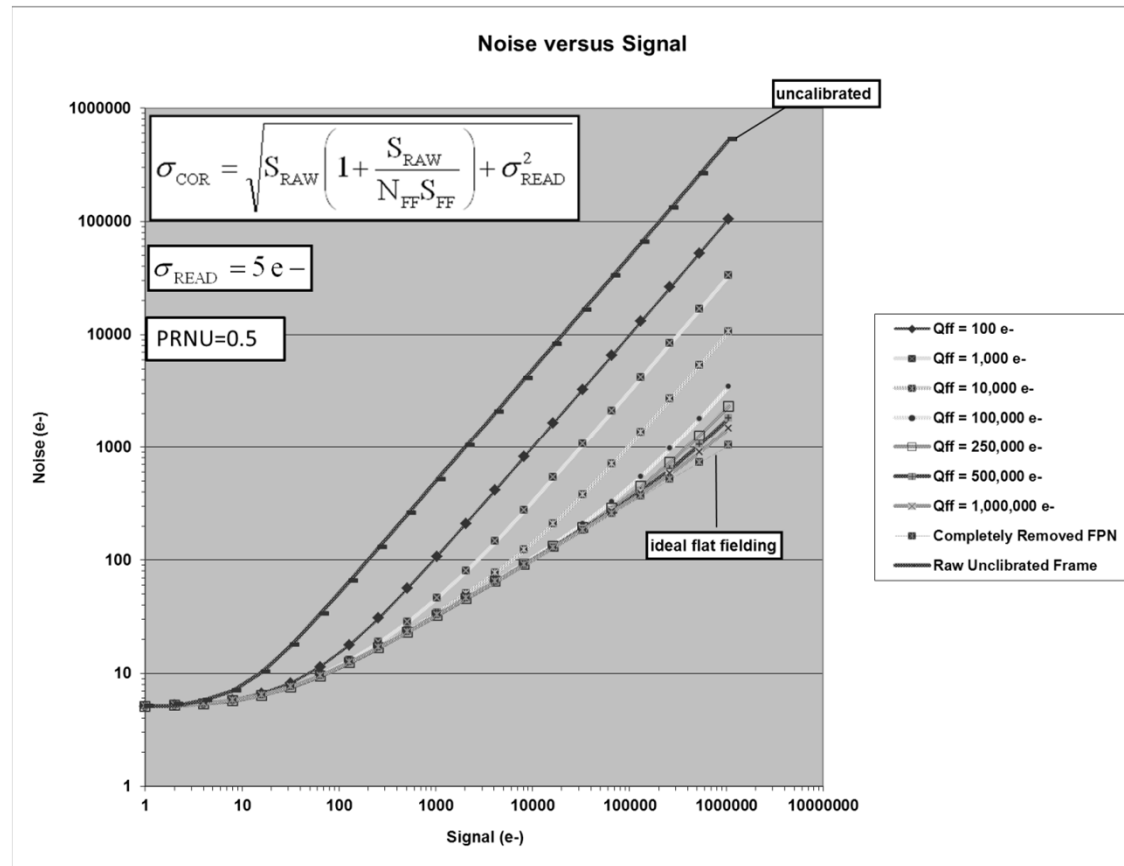

PRNU = 0.10

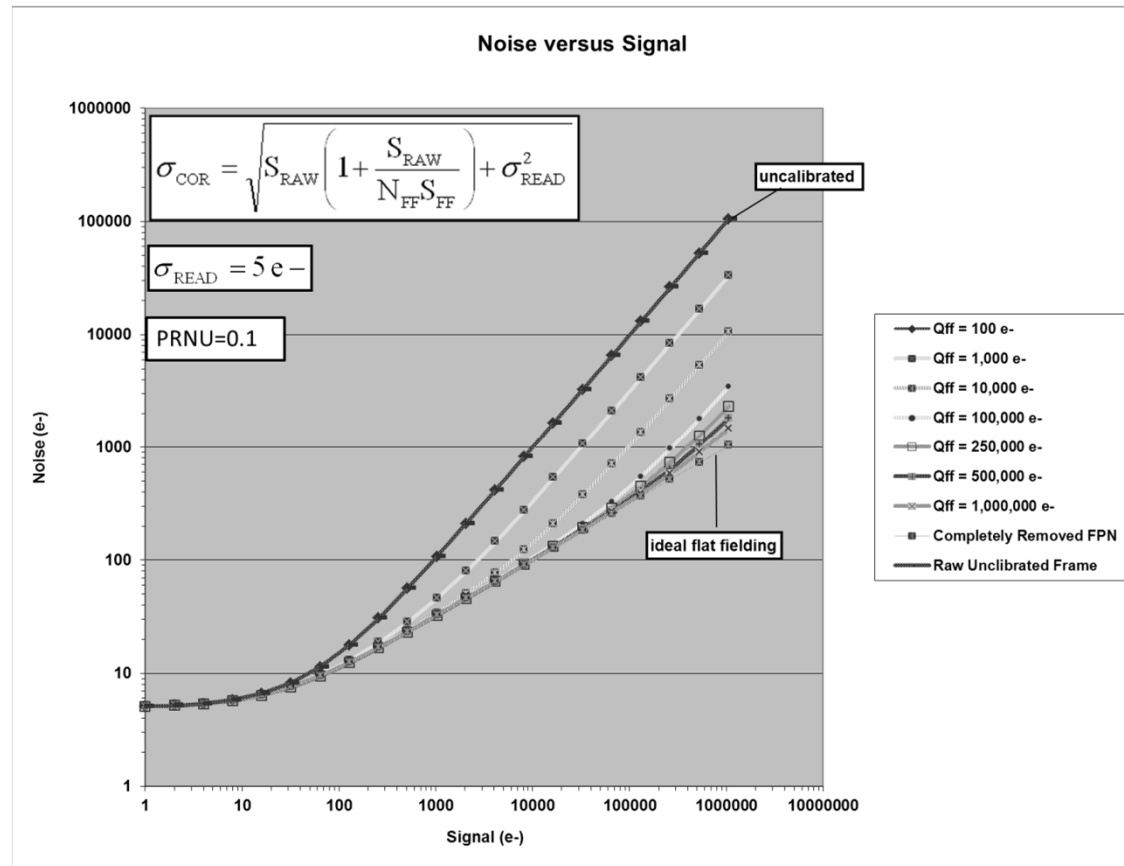

PRNU = 0.05

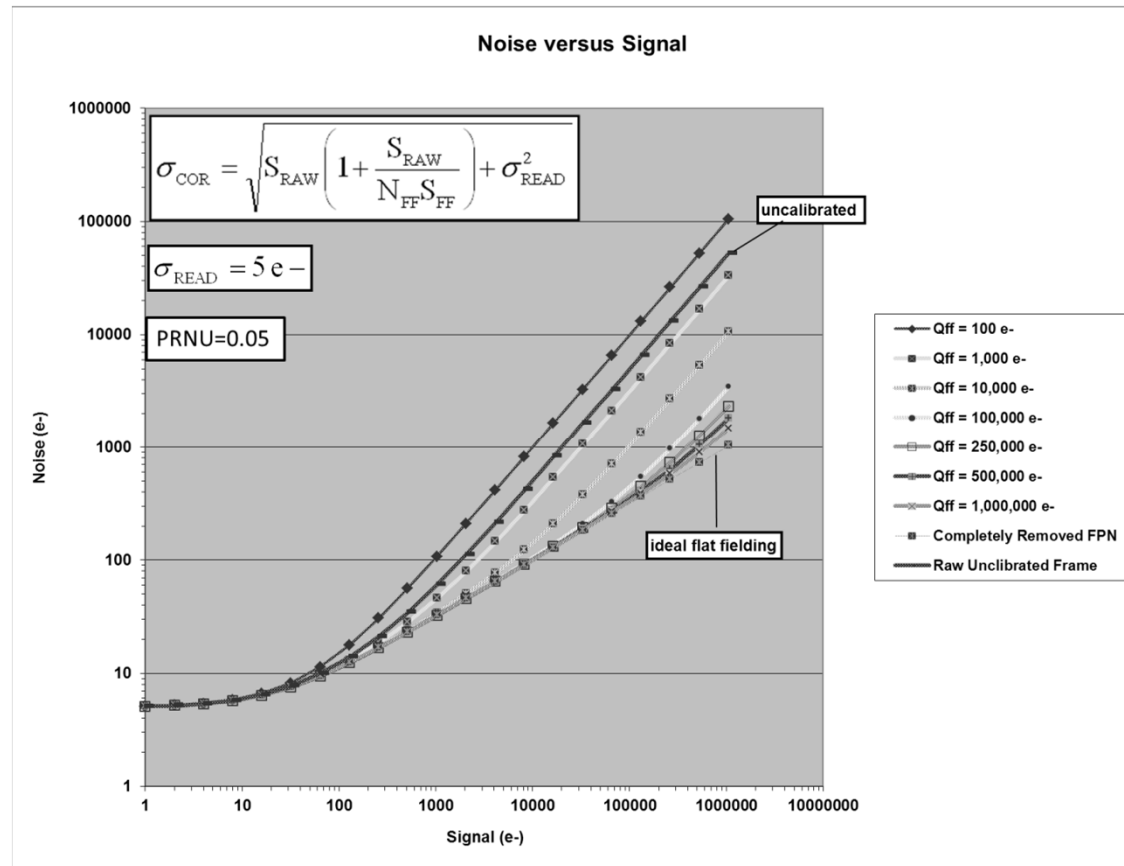

PRNU = 0.01

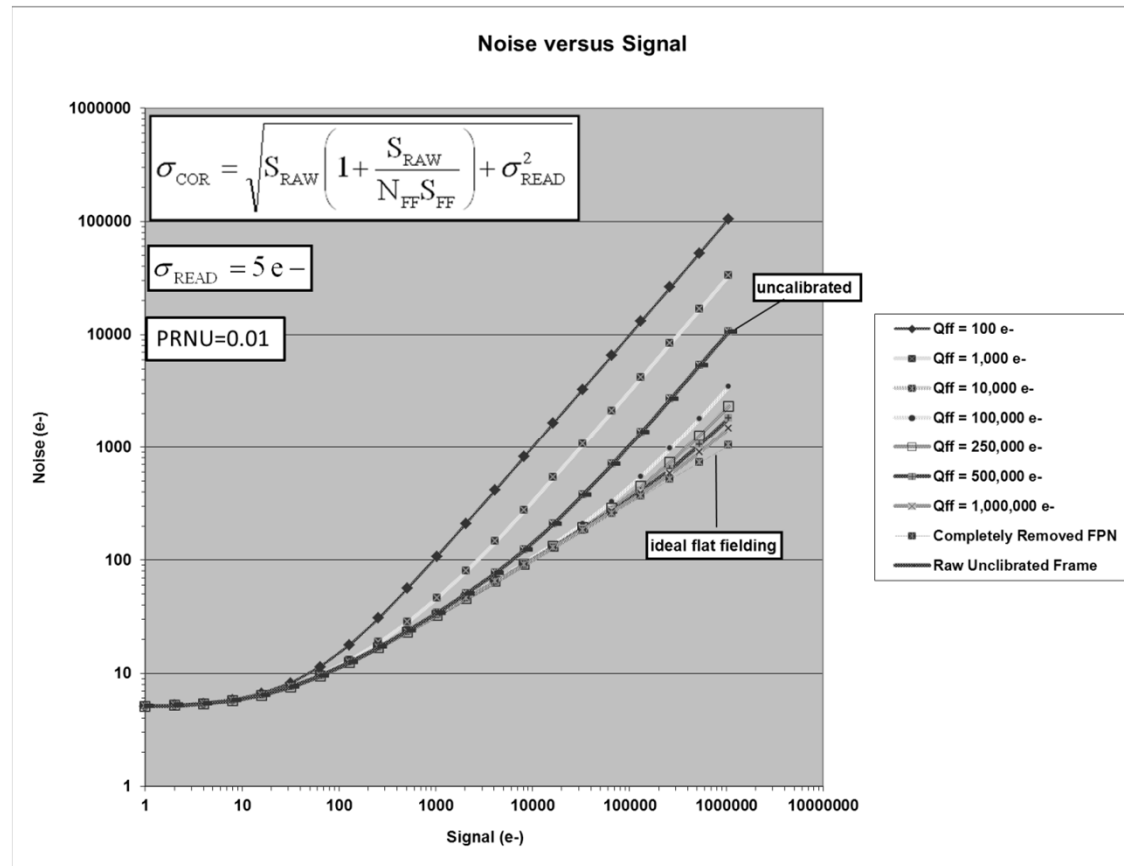

PRNU = 0.005

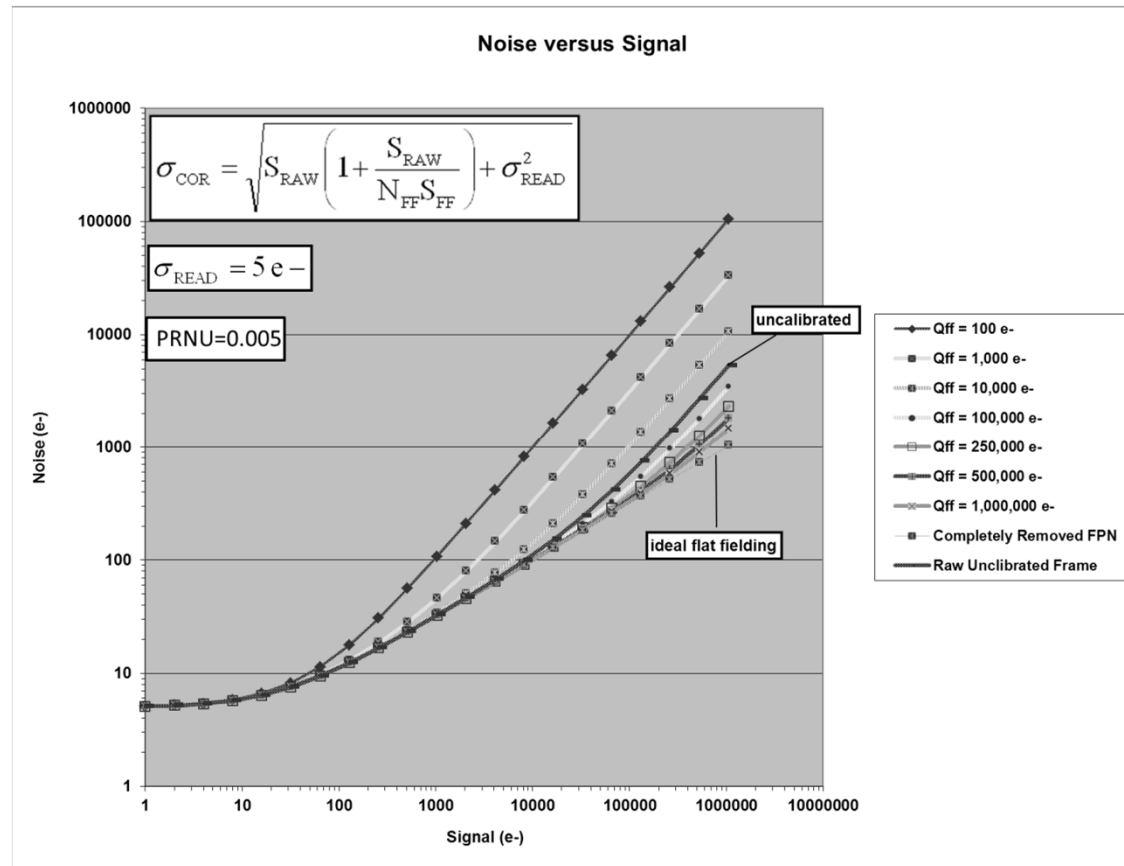

PRNU = 0.001

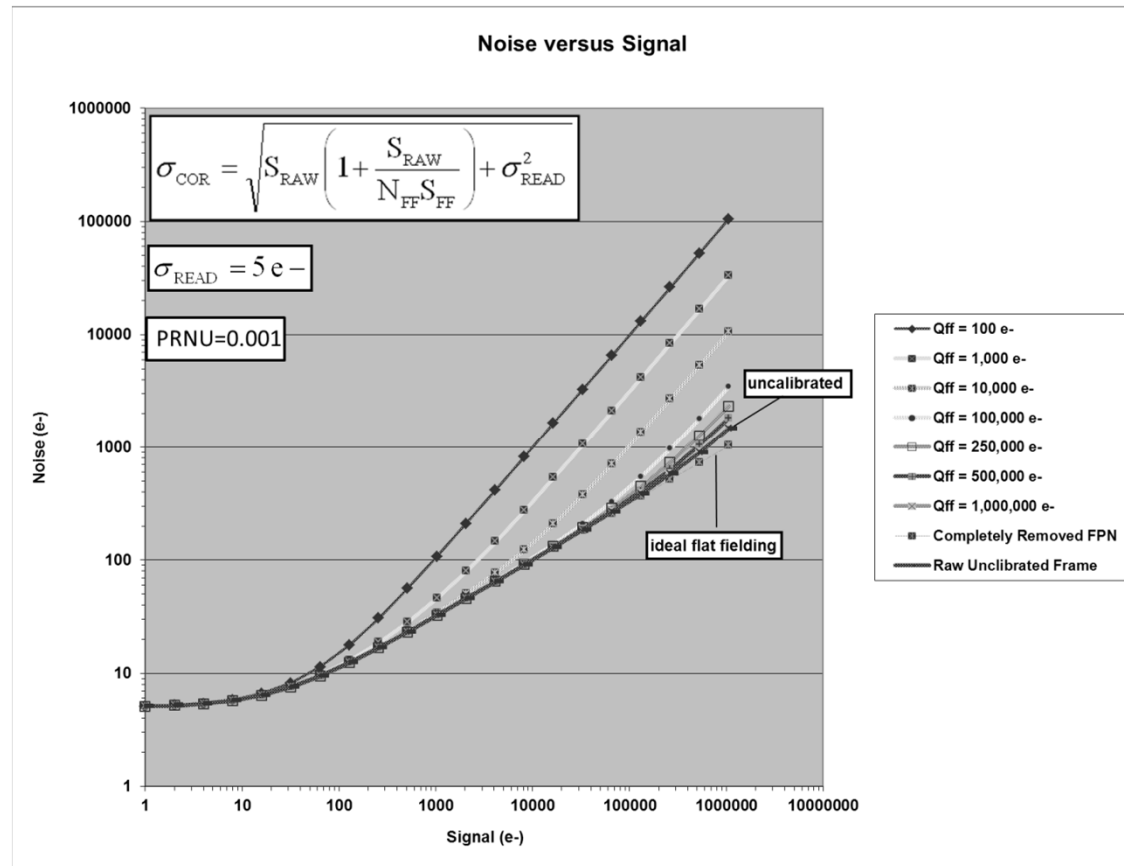

Observing PRNU vs Qff effect

- The next slides will show S/N-FFPTCs for varying PRNU values ranging from 0.5 to 0.001
- Observe how the “uncalibrated” curve moves to progressively higher numbers of electrons needed in the flat-field set to match the “uncalibrated” curve as the PRNU decreases

PRNU = 0.5

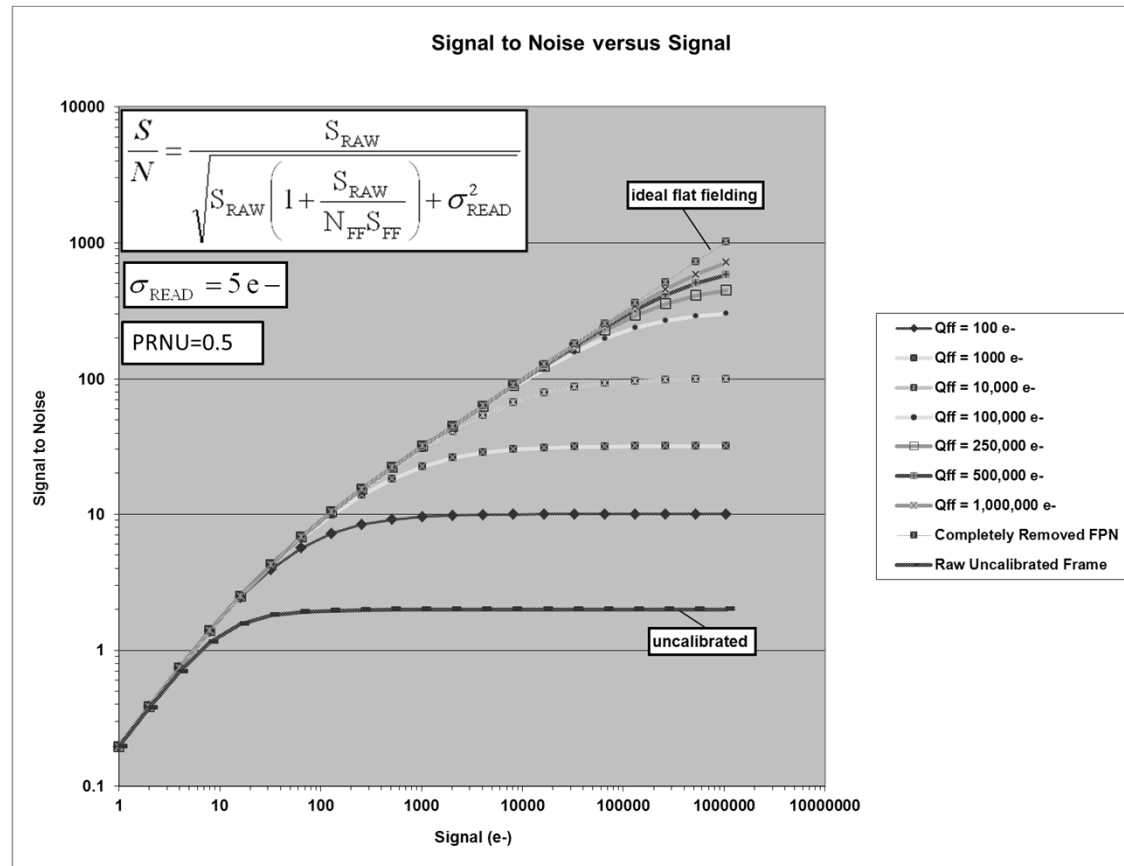

PRNU = 0.1

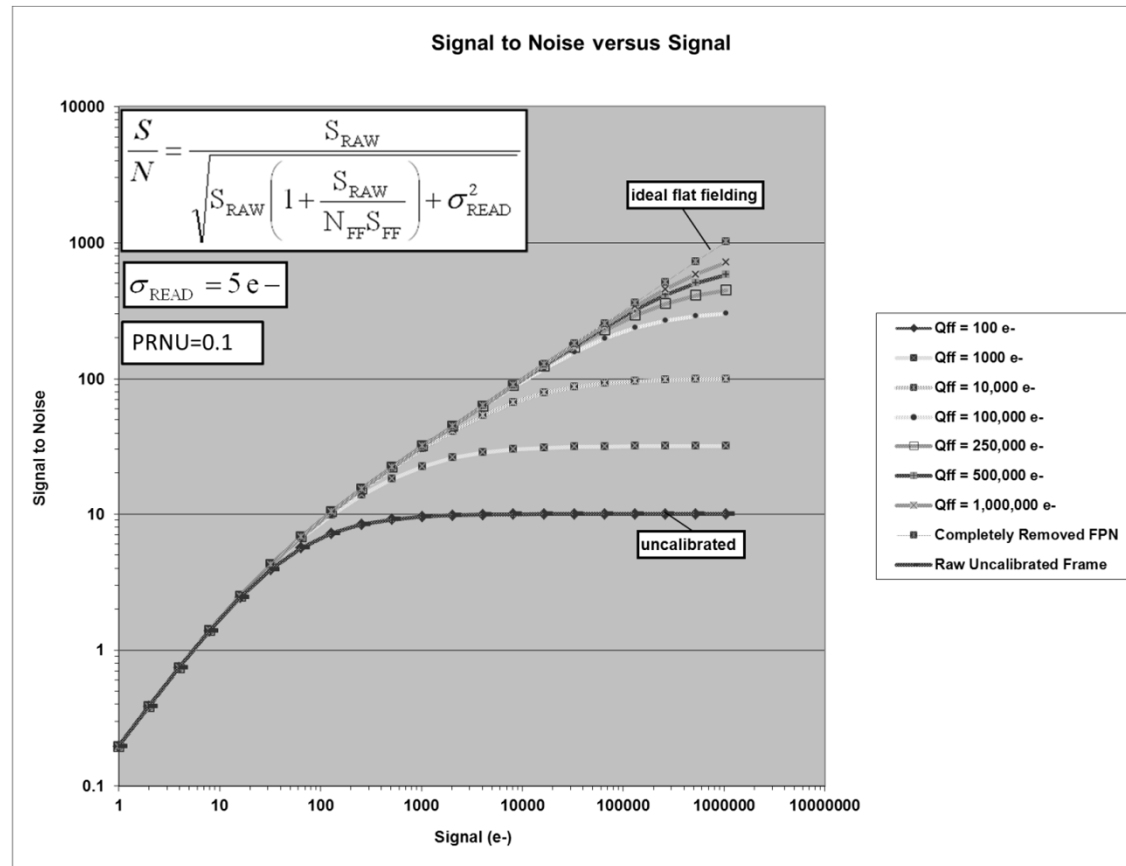

PRNU = 0.05

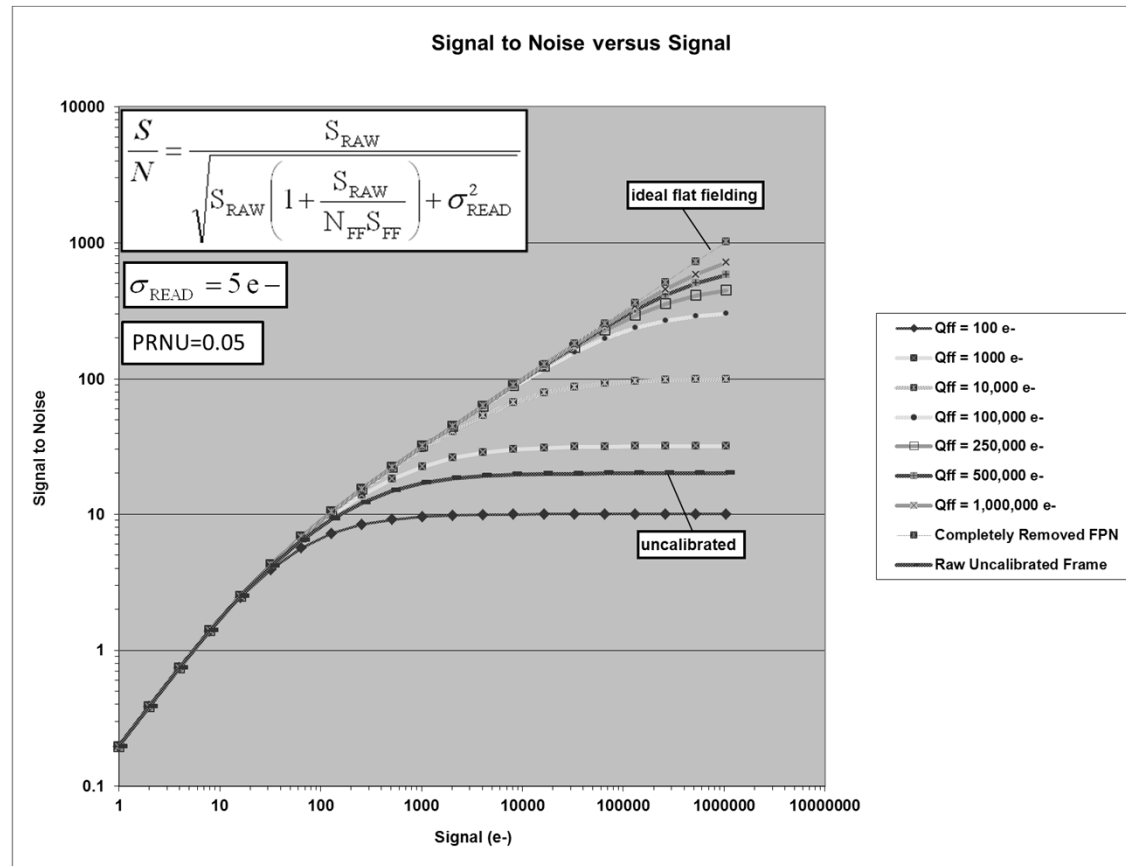

PRNU = 0.01

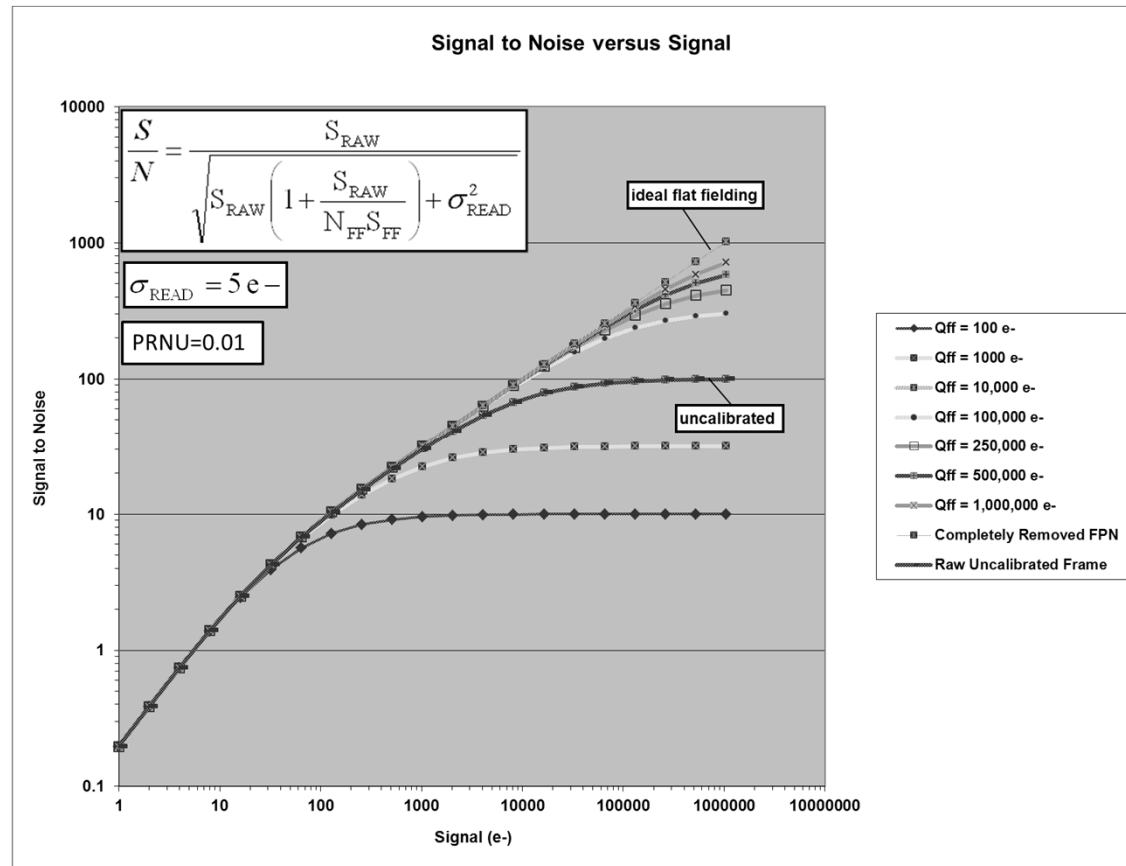

PRNU = 0.005

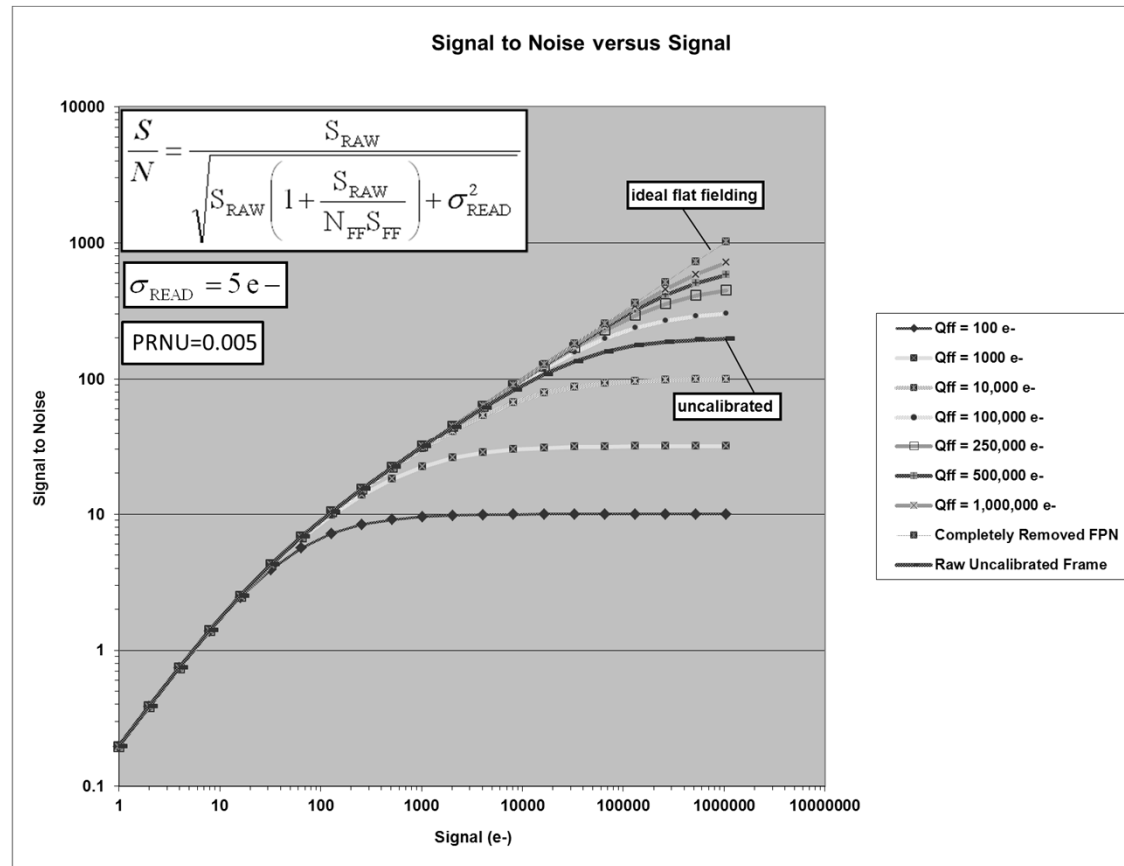

PRNU = 0.001

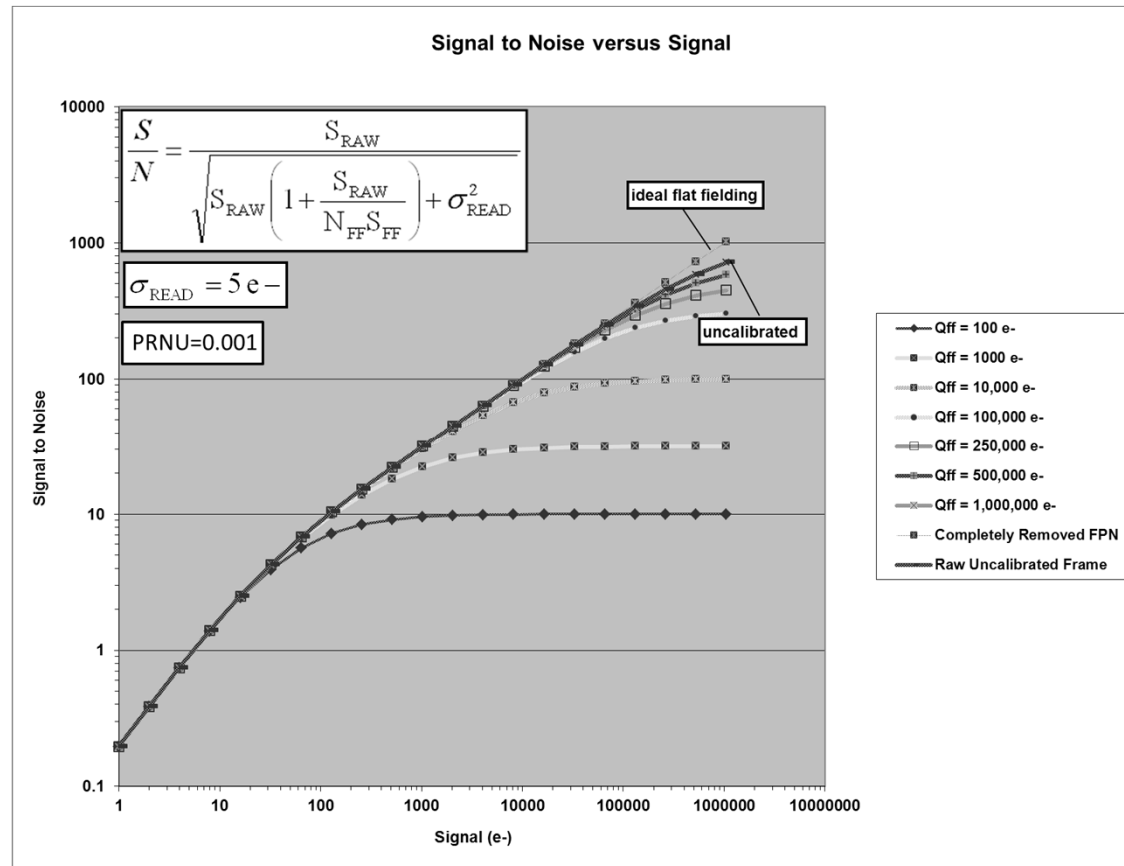

The relationship between well capacity and optimum electron-count in flat-field set

- For good flat-fielding, the signal level in the flats needs to be higher if the signal level in the raw image is higher
 - This is shown in each of the FFPTCs we have seen
 - As signal increases, more electrons are needed in the flat set to remove the FPN
 - The limit to the signal is the well capacity

Finding recommended electron-count for flat-field set for selected sensors

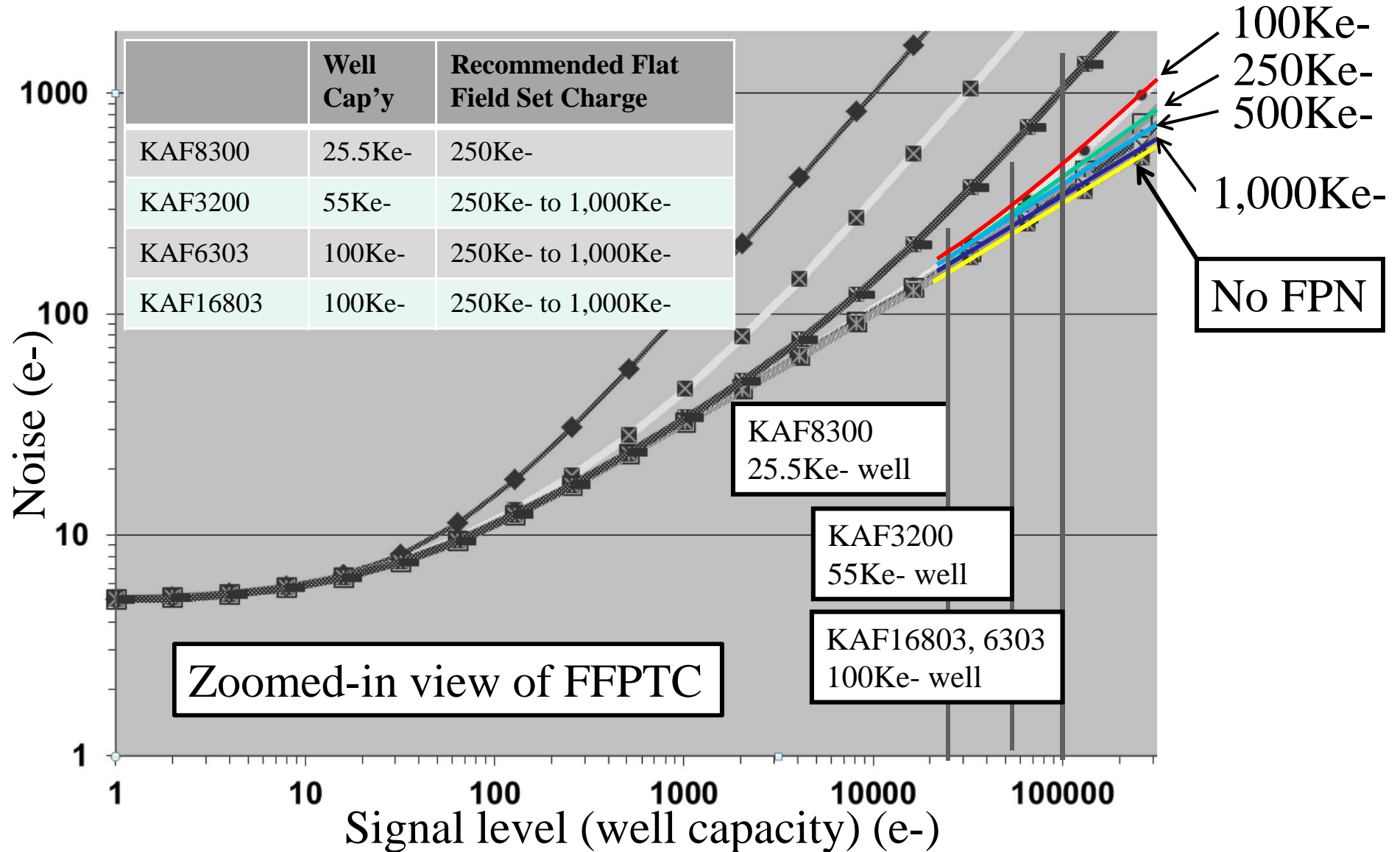

Glossary

- PRNU (Photo Response Non Uniformity)

Revision History

- 23 Jan 2012: initial release of part 1
- 24 Jan 2012: Goals page inserted as p4. revisions to PP 6, 9, 14, glossary added at end re-release of part 1
- 25 Jan 2012: added page numbers and finished part 2
- 26 Jan 2012: added part 3